

MATERIAL SUPPORTING THE AGENDA

Volume XIXa

September 1971 - December 1971

This volume contains the Material Supporting the Agenda furnished to each member of the Board of Regents prior to the meetings held on September 8, October 22, and December 2-3, 1971.

The material is divided according to the Standing Committees and the meetings that were held and is submitted on three different colors, namely:

- (1) white paper - for the documentation of all items that were presented before the deadline date
- (2) blue paper - all items submitted to the Executive Session of the Committee of the Whole and distributed only to the Regents, Chancellor, and Chancellor Emeritus
- (3) yellow paper - emergency items distributed at the meeting.

Material distributed at the meeting as additional documentation is not included in the bound volume, because sometimes there is an unusual amount and other times maybe some people get copies and some do not get copies. If the Secretary were furnished a copy, then that material goes in the appropriate subject folder.

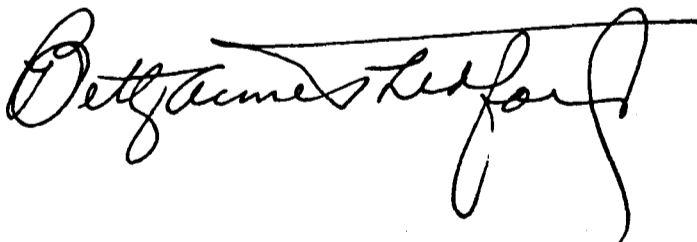
A handwritten signature in cursive script, reading "Betty James Hedford". The signature is written in black ink and is positioned in the lower right quadrant of the page.



THE BOARD OF REGENTS OF THE UNIVERSITY OF TEXAS SYSTEM

Material Supporting

Agenda

Meeting Date: September 8, 1971

Meeting No.: 693

Name: Office copy -

Handwritten notes:
eja-10
Sta 16 +
Med - 11 P
8 P
Exec. Session
Sta 7

CALENDAR
BOARD OF REGENTS
OF
THE UNIVERSITY OF TEXAS SYSTEM

September 8, 1971

Place: U. T. Austin
Austin, Texas

Meeting Room: Main Building, Room 212

Wednesday, September 8, 1971. --The order of the meetings is set
out below:

9:00 a.m. Executive Committee
Academic and Developmental Affairs Committee
Buildings and Grounds Committee
Medical Affairs Committee
Land and Investment Committee
Committee of the Whole
Meeting of the Board

12:00 noon - Lunch will be served in the Academic Center.

Telephone Numbers

Offices:

Board of Regents	471-1265
Chancellor LeMaistre	471-1434
Chancellor Emeritus Ransom	471-1741
Deputy Chancellor Walker	471-1743
President Spurr	471-1233

Hotels:

Sheraton-Crest Inn	478-9611
Stephen F. Austin Hotel	476-4361
Villa Capri Motor Hotel	476-6171

Airlines:

Braniff International	476-4631
Continental	477-6716
Texas International	478-9585

NOTE: Chancellor LeMaistre has asked that the institutional heads and the respective business officers sit in Section 1 and 1a so that he can easily locate them if needed at the meeting. He has also asked that those with whom he may need to confer sit in the area near his place.

DIAGRAM OF MEETING ROOM

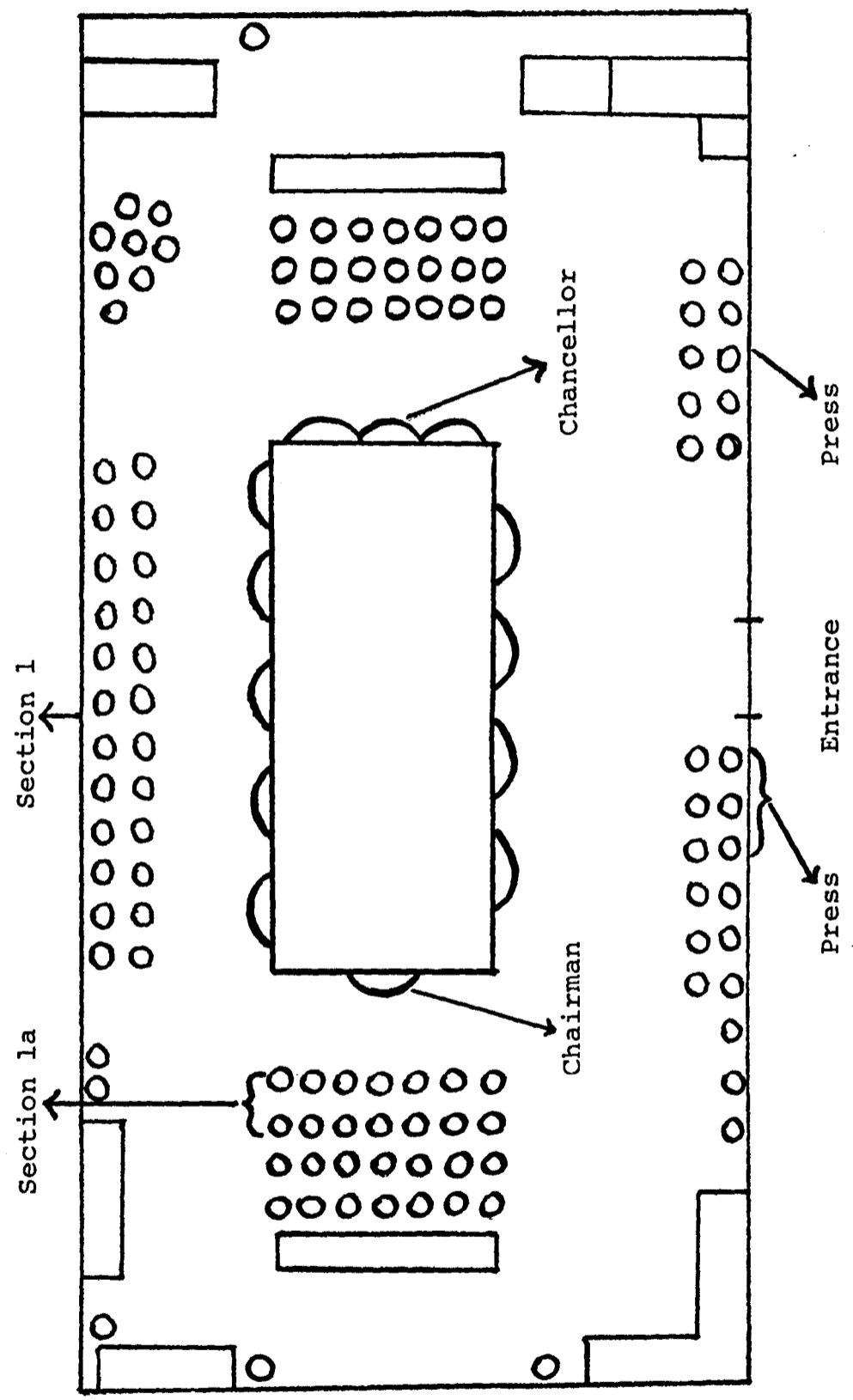

**Executive
Committee**

EXECUTIVE COMMITTEE

Date: September 8, 1971

Time: 9:00 a. m.

Place: Main Building, Room 212
The University of Texas at Austin
Austin, Texas

Page
EXEC

1. U. T. Austin, U. T. Arlington, Galveston Medical Branch and M. D. Anderson: Amendments to the 1970-71 Budgets (11-B-70)

Below

-
1. U. T. Austin, U. T. Arlington, Galveston Medical Branch and M. D. Anderson: Amendments to the 1970-71 Budgets (11-B-70). --During the preparation of this volume, the following amendments to the 1970-71 operating budgets for The University of Texas at Austin, The University of Texas at Arlington, The University of Texas Medical Branch at Galveston and The University of Texas M. D. Anderson Hospital and Tumor Institute at Houston have been received for submission to the Executive Committee. The ballots will not have been returned in time to include the results in this volume. I am setting out on Pages 2 - 6 these proposed amendments and the results of the ballots can be announced at the meeting.

Sources of Funds - Departmental Appropriations
(Unless Otherwise Specified)

(All rates set out below are full time rates: salary rate indicates a 12 months' full time rate and academic rate indicates a 9 months' full time rate.)

The University of Texas at Austin

Item No.	Explanation	Present Status	Proposed Status	Effective Dates
54.	Office of the Registrar - Official Publications Transfer of Funds	From: Unappropriated Balance - General Funds	To: Official Publications - Maintenance and Operation	
	Amount of Transfer	\$ 50,000	\$ 50,000	---
<p>This transfer is necessary to fund additional publication costs of catalogs and other bulletins. These increased costs relate to increased volume of printing as enrollment increases, increase in unit cost of publications -- such as the Engineering catalog and the General Information bulletin. In addition, the change in format from the Fall Semester Course Schedule to the larger format for the Spring Semester Schedule that incorporated "unique numbers" necessary for computerized registration doubled the cost of that particular publication.</p>				
55.	Miscellaneous General Institutional Expenses - Insurance Transfer of Funds	From: Unappropriated Balance - General Funds	To: Automobile and General Liability Insurance	
	Amount of Transfer	\$ 8,919	\$ 8,919	---
<p>This transfer is to provide the additional funds needed to pay the annual renewable premiums due for U. T. Austin's part of the System-wide policies with Safeguard Insurance Company.</p>				
56.	Auxiliary Enterprises - Intercollegiate Athletics Transfer of Funds	From: Intercollegiate Athletics - Unappropriated Balance	To: Intercollegiate Athletics - Wages \$ 6,000 Dining Facilities 18,000 Other Expenses <u>62,340</u>	
	Amount of Transfer	\$ 86,340	<u>\$86,340</u>	

The additional wages are needed for student assistants and stadium seat board crews.

The new operation of the dining hall with Night Hawk Restaurants requires \$18,000 more than was budgeted. It was brought to the attention of the Athletics Council that an emergency had arisen in the kitchen of the Athletics Dining Facility. The exhaust hoods in the kitchen were originally designed to accommodate closed-fire cooking and with the conversion of these facilities to open-fire cooking, it has become necessary to alter the ventilation system because the open-fire cooking creates a fire hazard. The design for the correction has been approved by the appropriate University authorities and the University fire marshal. The cost is estimated at \$12,000.

The University of Texas at Austin (continued)

Item No.	Explanation	Present Status	Proposed Status	Effective Dates
56.	Auxiliary Enterprises - Intercollegiate Athletics (Continued)			
	<p>The additional expenses were detailed in the minutes of the Athletics Council for the July 21, 1971 meeting, including such additional costs as \$13,000 for basketball game expenses; \$13,200 for baseball for NCAA play-offs and work on field up-keep and dugouts; \$9,040 for swimming, including 50% of the cost of an electronic timer; \$14,300 for track, including the other 50% of the timer plus field work involving landing pits for high-jump and pole vault; \$1,300 for cross country expenses of equipment and travel to meets; and \$10,000 for increased engraving and printing costs due to new format of football programs. Offsetting these increases were certain reductions in costs, such as \$8,000 in insurance premiums and general repairs of facilities, \$5,800 in reduced costs of travel, etc.</p>			
57.	Auxiliary Enterprises - Gregory Gym Store Transfer of Funds	From: Gym Store - Unappropriated Balance \$14,000 Reserve for Budget Adjustments <u>2,000</u>	To: Gym Store - Other Operating Expenses \$ 16,000	---
	Amount of Transfer	<u>\$16,000</u>		
	To purchase inventory for resale.			
58.	Auxiliary Enterprises - Student Health Center - The Pharmacy Transfer of Funds	From: The Pharmacy - Unappropriated Balance \$ 10,000	To: The Pharmacy - Other Expenses \$ 10,000	---
	Amount of Transfer	\$ 10,000		
	To purchase inventory of drugs and pharmaceuticals for resale.			
59.	Auxiliary Enterprises - Student Government Transfer of Funds	From: Student Government - Unappropriated Balance \$ 8,300	To: Student Government - Student Assembly Scholarship Grants \$ 125 Other Expenses <u>8,175</u> <u>\$8,300</u>	
	Amount of Transfer	\$ 8,300		

The student Assembly Scholarship Grant is for Andrew Heller.

Following are the estimated amounts that the Student Government will exceed

The University of Texas at Austin (continued)

Item No.	Explanation	Present Status	Proposed Status	Effective Dates
59.	Auxiliary Enterprises - Student Government (Continued)			

its internal budget for 1970-1971. The internal budget anticipated the use of the \$8,000 balance forwarded (1969-70) but no document was prepared to authorize its use and no Regental approval was obtained

Telephone	\$ 800
Postage	600
Social Security (OASI)	1,000
Salaries	2,450
Physical Plant Expense	300
Equipment	525
Blacks Regional Conference	<u>2,500</u>
	<u>\$8,175</u>

Regarding the overdraft that is in the report, the new President, Bob Binder, expressed a view that it resulted from insufficient communication during last year's operations which in turn led to inadequate budgetary control. The new Student Government is making every effort to keep expenses in check.

The University of Texas at Arlington

Item No.	Explanation	Present Status	Proposed Status	Effective Dates
12.	Auxiliary Enterprises- Student Center Facilities			
	Transfer of Funds	From: Student Center Facilities - Unappropriated Balance	To: Student Center Facilities - Maintenance and Operation	
	Amount of Transfer	\$ 14,000	\$ 14,000	---

The transfer is needed to cover the increase in costs of power and chilled water used in the Student Center Building.

The University of Texas Medical Branch at Galveston

Item No.	Explanation	Present Status	Proposed Status	Effective Dates
14.	Plant Funds - Capital Improvements, Including Equipment			
	Transfer of Funds	From: Unappropriated Balance via Estimated Income	To: Capital Improvements, Including Equipment	
	Amount of Transfer	\$985,100	\$985,100	---
	Project Allocations:			
1.	Purchase and installation of a Pathological incinerator for human tissue		\$ 35,000	
2.	Demolition of Boilers		15,000	
3.	First phase of new greenhouse operations - 1300 Block of Mechanic Street		40,000	
4.	Install piling bulkhead around bay side of Moody State School property and place rip-rap and fill as needed		35,000	
5.	Landscape area between 10th and 11th Street on Mechanic Street and provide landscaping in new land acquisition area		75,000	
6.	Remodel area in Keiller Building for the Department of Preventive Medicine and Community Health to provide additional research and office space		33,700	
7.	Install gasoline storage tank and pump, and pave Physical Plant service area		25,000	
8.	Remove Print Shop from basement of Ashbel Smith Building to Medical Illustration Building		40,000	
9.	Pave service drive and landscape between Keiller Building and Gail Borden Building		20,000	
10.	Provide Additional Office Space in Keiller Building for Vice-President for Academic Affairs		35,400	
11.	John Sealy Hospital Area Renovations		100,000	
12.	Hospital Equipment to supplement Legislative Appropriations		400,000	
13.	Demolition of houses acquired during the 1962 land acquisition program		5,000	
14.	Install hyperbaric chamber for the Marine Biomedical Institute		75,000	
15.	Remodel recently purchased brick house at 1202 Market Street for Kidney Detection Program		6,000	
16.	Remodel recently purchased brick house at 1205 Mechanic Street for Community and Social Psychiatry Program		<u>45,000</u>	
	Total Appropriation		<u>\$985,100</u>	

The University of Texas M. D. Anderson Hospital and Tumor
Institute at Houston

Item No.	Explanation	Present Status	Proposed Status	Effective Dates
4.	Pharmacy and Diagnostic Radiology Service Transfer of Funds	From: Unappropriated Surplus	To: Pharmacy - Maintenance and Operation Diagnostic Radiology Service - Maintenance and Operation	\$170,000 <u>30,000</u>
	Amount of Transfer	\$200,000		<u>\$200,000</u>

Funds previously budgeted for the Maintenance and Operation costs of the Pharmacy are approximately \$170,000.00 less than our actual requirements for the year. Due to the full activation of the Intravenous Solution Additive Program in our Pharmacy during the year, costs of solutions have been much greater than were anticipated at the time of preparation of the initial 1970-71 Budget. However, it should be pointed out that revenues from Pharmacy services have increased at a greater rate than costs, therefore the increased funds requested have been more than offset by increased revenues.

The additional amount of \$30,000.00 is requested for increased Maintenance and Operation costs for operation of the Diagnostic Radiology Service. This is brought about by increases in the cost of film and solutions, maintenance of equipment and by increased volume in this department.

**Aca. & Dev.
Affairs Com.**

ACADEMIC AND DEVELOPMENTAL AFFAIRS COMMITTEE

Date: September 8, 1971

Time: Following the meeting of the Executive Committee

Place: Main Building, Room 212
The University of Texas at Austin
Austin, Texas

	<u>Page A & D</u>
1. U. T. System: <u>Chancellor's Docket No. 50</u>	2
2. U. T. Austin: Approval of Model Affiliation Agreement for College of Pharmacy and Approval for the Execution of Such Agreement with Seton Hospital, Austin	2
3. U. T. Austin: Reconstitution of Athletics Council	7
4. U. T. Austin: Establishment of the Piner Scholarship Fund in Architecture	11



THE UNIVERSITY OF TEXAS SYSTEM

Office of the Chancellor

601 COLORADO STREET, AUSTIN, TEXAS 78701

*These were
distributed at
the meeting
9/7/71.*

September 3, 1971

B47

MEMORANDUM

TO: Regent Joe Kilgore

FROM: Charles A. LeMaistre, M.D. *cal*
Chancellor

SUBJECT: Response to Exceptions to Chancellor's Docket
No. 50

As you have approved, I am transmitting herewith to you the System Administration response to those exceptions in the Chancellor's Docket for the September 8, 1971, Board meeting raised by Regent Nelson. I am also sending a copy of the response directly to Regent Nelson.

I sincerely hope that this response will clarify and satisfy the exceptions which have been raised and conserve the time of the entire Board in considering these matters.

CAL:jm

Attachment

cc: Regent Joe Nelson
Miss Betty Anne Thedford
Mr. E. D. Walker
Dr. Kenneth Ashworth
Dr. William H. Knisely

RESPONSE TO EXCEPTIONS IN
CHANCELLOR'S DOCKET NO. 50

Regional Medical Program of Texas

Page C-5

In the progress report on the Regional Medical Program of Texas and related attachments which were mailed to all members of the Board of Regents on August 27, 1971, Attachment B lists those projects and activities which constitute the expenditures for the remainder of the federal Regional Medical Program grant. In essence, this is:

Attachment B Total	\$ 897,657
Coordinator's Office, Docket	<u>692,343</u>
	\$1,590,000

With regard to the travel questions, following is a summary of travel for Regional Medical Program Core Staff personnel through July, 1971, and the budget detail approved by the Regional Advisory Group to develop the travel request in the 1971-1972 budget.

(See Attached.)

REGIONAL MEDICAL PROGRAM OF TEXAS
OFFICE OF THE COORDINATOR
TRAVEL EXPENDITURES
OCTOBER 1, 1970 - JULY 31, 1971

	IN STATE	OUT STATE	TOTAL
CORE STAFF	\$24,932.10	\$5,754.44	\$30,686.54
<u>Core Staff Personnel Who Traveled</u>			
Charles B. McCall, M.D., Coordinator			
Ross L. McLean, M.D., Medical Consultant			
David K. Ferguson, Director of Program Management and Deputy Coordinator			
Stanley Burnham, Director of Professional Programs			
N. Don Macon, Director of Community Health Programs			
Mrs. Louise Miller, Chief of Administrative Services			
Robert O. Humble, Chief of Evaluation and Data Mgmt.			
Mrs. Maria Flood, Regional Representative			
Henry G. Faulk, Jr., Regional Representative			
John L. Oxley, Regional Representative			
Marian M. Strohmeier, Regional Representative			
Robert Anderson, Operations Officer			
Bill F. Jones, Operations Officer			
Robert Plunkett, Operations Officer			
Beverly A. Drawe, Information Officer			
William H. Lane, Operations Officer			
Mrs. Eleanor Lerro, R.N., Operations Officer			
Hubert D. Reese, Evaluation Specialist			
Thomas V. Sanders, Fiscal Officer			
Mrs. Darlene Gouge, Research Associate			
Mrs. Sylvia M. Cantu, Administrative Secretary			
REGIONAL ADVISORY GROUP, EXECUTIVE COMMITTEE, TASK FORCES AND COMMITTEES	8,363.93	-0-	8,363.93
CONSULTANTS	46.00	172.00	218.00
TOTAL EXPENDITURES	\$33,342.03	\$5,926.44	\$39,268.47

TRAVEL DETAIL APPROVED BY REGIONAL ADVISORY GROUP FOR 1971-72

Coordinator's Office			
Coordinator (\$300/Mo.)	\$3,600		
Deputy Coordinator (\$167/Mo.)	2,000		
Director Professional Programs (\$167/Mo.)	2,000		
Director of Education (\$200/Mo.)	2,400		
Director of Community Health Planning (\$250/Mo.)	3,000		
Chief of Evaluation and Eval. Specialist (\$250/Mo.)	3,000		
Chief of Program Development (\$167/Mo.)	2,000		
Operational Officers (3 @ \$150/Mo. each)	5,400		
Chief of Adm. Services and Fiscal Officer (\$67/Mo.)	800		
Regional Representatives (7 @ \$200/Mo. each)	16,800	\$41,000	
Regional Advisory Group, Executive Committee Task Forces and Committees		14,400	
TOTAL		\$56,400	

U.T. Austin

Item 63, Page M-9

This was explained in Chancellor LeMaistre's memo to the Board dated August 31, 1971. It was the understanding of President Spurr and Chancellor LeMaistre, following the last discussion of this matter with the Board, that the required amendments to the grant would be processed via the docket.

Item 66, Page M-9

This was apparently held for the reporting of an item, while the typing of the remainder of the docket progressed. It was then decided that the item was not ready for docketing.

Item 72, Page M-10

The Drug Education project was funded by the U.S. Office of Education in June, 1970, for one year to June, 1971. The total amount was \$88,200. The College of Pharmacy received the grant but the Medical School at San Antonio loaned facilities for use during the summer from July 13 - August 7, 1970. Purpose of the grant was to train teams of people from 11 states including Texas in the recognition of drug abuse practices primarily in public schools. The teams consisted primarily of administrators and teachers from public schools plus some law enforcement officials. These persons were to return to their home states and train other personnel. Seventy-three persons were trained in the program.

Four such National Drug Education Training Centers were established in the United States by the U.S. Office of Education. The University of Texas Center had primary responsibility for southern states.

Approximately \$3,000 remains in the budget for use through the requested December extension. This amount will be used to complete the evaluation of the project and for consultation with states on their local programs. (Three states remain which have requested consultant help which could not be completed during the original grant period.)

Item 80, Page M-11

This project is to train educators and master teachers in the educational assessment of the handicapped and the development of appropriate educational programs for such students. This is not a program related to the training of specialists in the treatment of the handicapped but rather to the development of teachers who are qualified and expert in how to optimize the educational experience of the handicapped. This is a program for educators, not diagnosticians or specialists in the treatment of mental or physical disorders. Educators are prepared in this program to assist students in the following areas: visually impaired, learning disabilities, emotionally disturbed, mentally retarded, crippled or health impaired, vocational and rehabilitation education, early childhood development, and speech and hearing difficulties.

This program at U.T. Austin requests funding for the third year. It is one of seventy such centers in the country.

Item 82, Page M-11

This was explained in Chancellor LeMaistre's memo to the Board dated August 31, 1971. It was the understanding of President Spurr and Chancellor LeMaistre, following the last discussion of this matter with the Board, that the required amendments to the grant would be processed via the docket.

Dallas Medical School

Item 25, Page S-7

The effective date of Dr. Schermerhorn's employment, according to Request for Budget Change No. 385, is August 16, 1971. The \$1,376.26 transfer of funds is to pay his salary from August 16, 1971, through August 31, 1971, calculated at the annual rate of \$32,000. The docket write-up is in error in that the effective date of employment should have been reported.

Extra Item

Mr. Bill F. Jones' resignation from the Regional Medical Program of Texas effective January 31, 1971, was reported in the System Docket for March 12, 1971. He was appointed Assistant to the Dean at The University of Texas Southwestern Medical School at Dallas for 100 percent time at an annual rate of \$19,000 effective February 1, 1971. This was reported in that institution's docket of April 23, 1971. The budget for 1971-1972 continues Mr. Jones in his present position, at 100 percent time, at an annual rate of \$20,000.

With regard to the assignment of Mr. Jones to coordinate and cooperate with Texas Instruments in the development of this HSMHA contract:

- (1) Texas Instruments requested the assignment of a liaison person, on approximately one-half time basis, and offered to pay the cost of these services from the proceeds of contract.
- (2) Dean Sprague agreed to the assignment of Mr. Jones on approximately one-half time effective August 3, 1971, for three or four months to Texas Instruments, but declined to have him paid through the grant funds. Because of certain matters regarding HMO's pending

before the Regents, this assignment was terminated August 17, 1971, and no further relationships have occurred.

(3) In Dean Sprague's opinion, Mr. Jones' assignment would have direct benefit to the medical school by allowing him to become familiar with:

(a) The HMO concept of health care delivery

(b) The appropriate ways in which the HMO concept could be related to the process of medical education and training. This assignment for Mr. Jones was construed to be in consonance with the Policy Statement for Development of Medical Education in The University of Texas System adopted by the Board of Regents in January, 1969.

For these reasons there was no change of status that would require reporting in the docket.

Item 6, Page ST-5

Dr. Glen K. Arney was originally appointed to the Medical School faculty (with tenure) on August 1, 1970, and paid from State Appropriated funds; this is not his first approval for tenure, just a change in fund source. Dr. Arney is not now and was never paid from OEO Grant funds. The grant specified in the docket item is not the OEO grant; it is that institution's basic improvement grant. Dr. Arney is not the acting director of the OEO Project.

Item 9, Page ST-5

Dr. Lloyd E. Berry's reappointment recommendation is for an effective date of July 1, 1971, and is a routine renewal recommendation for authority to maintain his status after June 30, 1971. All personnel paid from grant funds must routinely be reappointed following the termination of the grant fiscal year, in this case, June 30.

This particular item was judged as an important one to place in the docket due to the fact that we were asked to explain its absence from the Chancellor's Docket No. 49. The Board had not approved his tenure due to a clerical error which was only recently discovered. Effective with the publication of the U.T. System 1970-71 Operating Budgets, the designation (T) which represents tenure was inaugurated. Prior to September 1, 1970, tenure was assumed to be inherent in all appointments of Associate Professor or Professor rank unless specifically denoted as (without tenure). The Request for Budget Change (RBC 91) submitted through System Offices indicated (T); however, when the RBC-91 was placed in the docket for Regents

approval at their March 12, 1971, meeting, the (T) was inadvertently omitted.

It is difficult to convince professional faculty personnel (with tenure) that their performance has been less than satisfactory and ask them to leave our employ; many legal complications arise in such cases. Nationally and state-wide, the dismissal of tenured faculty has become difficult, to say the least. Letters of resignation from tenured positions are, on the contrary, not as difficult to use as authority to terminate a tenured faculty member from his position and salary. As we had previously assumed that Dr. Berry had tenure, his current academic and pay status have been planned for the effective date of his resignation (October 31, 1971). The next docket will contain an item changing, effective September 1, 1971, the source of Dr. Berry's salary from the OEO grant to Department of Medicine, Teaching Salaries. Dr. Berry submitted his resignation on August 11, 1971, to be effective October 31, 1971.

Item 10, Page ST-5

Dr. Douglas' reappointment recommendation is for an effective date of July 1, 1971, and a routine renewal recommendation for authority to maintain his status after June 30, 1971. His original appointment approved at the April 23, 1971, meeting of the Board was only for the period of his arrival (June 15, 1971) through the end of the first year of the Grant (June 30, 1971). As in the case of Dr. Berry, the Board has not approved his tenure due to a clerical error which was only recently discovered. Effective with the publication of the U.T. System 1970-71 Operating Budgets, the designation (T) which represents tenure was inaugurated.

Prior to September 1, 1970, tenure was assumed to be inherent in all appointments of Associate Professor or Professor rank unless specifically denoted as (without tenure). The Request for Budget Change (RBC-137) submitted through System Offices indicated (T); however, when the RBC-137 was placed in the docket for Regents' approval at their April 23, 1971, meeting, the (T) was inadvertently omitted.

(Comment by System Administration follows.)

With regard to Items 9 and 10, the action of System Administration to delete the tenure award to both Drs. Berry and Douglas was based on the "pink sheet" budget rule which provides that:

"Budgeted expenditures authorized from sources of funds other than General Budget Funds are contingent upon receipt of such funds. Appointments from such fund sources will not become an obligation of the Component Institution in the event the supplemental or grant funds are not realized."

Extra Item

The Board of Regents were not asked in the Chancellor's Docket #49 (July 30, 1971) nor have they been asked for the September 8, 1971, meeting to approve funding and renewal of the OEO Grant. The Office of Economic Opportunity (OEO), Washington Office, has not sent us official documentation of approval of the second year of the grant. Until the grant has been officially awarded, we cannot ask the Board for approval.

Galveston Medical Branch

Item 5, Page G-12

As part of the effort to do away with the "System Professor" title, those individuals, including Dr. McCall (who had held this title since his initial employment) were given academic titles at those institutional bases which were most interested in the utilization of their services on a time available basis. Certainly, the schools which made the offers of these academic positions were indicating their professional interest in these individuals as potential faculty at some future time.

As a result of this decision to make all faculty titles relate to a specific institutional base:

- a. Dr. LeMaistre is a Professor of Medicine at Dallas Medical School
- b. Dr. Knisely is a Professor of Anatomy at San Antonio Medical School
- c. Dr. McCall is a Professor of Medicine at Galveston Medical Branch.

Since all of these title designations are without time allocation and without salary, the basic responsibilities of the individual are not disturbed, but the institution does have a "string" to the man for consultant services and future faculty consideration.

Public Health School

Items 2, 3, and 4, Page PH-5

Reproduced below is a letter from Associate Dean Remington which responds to the questions contained in the exception.



THE UNIVERSITY OF TEXAS AT HOUSTON
SCHOOL OF PUBLIC HEALTH

P. O. Box 20186
(713) 741-0400

Astrodome Station

Houston, Texas 77025

OFFICE OF THE DEAN

2 September 1971

Charles A. LeMaistre, M.D.
Chancellor
The University of Texas System
601 Colorado Street
Austin, Texas 78701

Dear Chancellor LeMaistre:

The following is in reply to your request concerning the U. S. -Mexico Border Project and the participation in this survey of three students from The University of Texas School of Public Health at Houston.

Invitation

At the request of Dr. Jorge Jimenez-Gandica, Secretary of the United States-Mexico Border Public Health Association, and yourself, The University of Texas School of Public Health entered into negotiations last summer to participate in a Border Health Survey in the El Paso-Juarez area in cooperation with the U. S. -Mexico Border Public Health Association, the University of Chihuahua, Mexico, Medical School and the School of Public Health, Mexico City, Mexico.

This project was directed by George M. Walker, Jr., Ph.D., Associate Professor of Health Services Administration, and several other members of our faculty, in conjunction with the Medical School of Chihuahua, Mexico. Mexican medical students conducted interviews in Juarez, while students from The University of Texas School of Public Health did the interviewing in El Paso. The methodology was comparable for both studies and was coordinated by Dr. Walker. The report of that survey was presented in the Spring of 1971 at the meeting of the U. S. -Mexico Border Public Health Association in Tucson, Arizona.

Funds to support the El Paso-Juarez Project were furnished in the amount of \$8,000.00 from the trustees of Houston Endowment, Inc., who have given funds in the amount of \$12,853.00 for the continuation of the study of health resources and needs in the U. S. -Mexico Border Area, with specific reference to the 1971 activity.

The project for summer 1971 is being conducted in Brownsville, Texas, and Matamoros, Mexico, in cooperation with the U. S. -Mexico Border Public Health Association, the Medical School of the University of Tamaulipas, Tampico, State of Tamaulipas, Mexico, and the School of Public Health at Mexico City, Mexico.

This project is again being coordinated by Dr. Walker with medical direction from Reuel A. Stallones, M.D., M.P.H. and Clarence Skrovan, M.D., M.P.H. Several other faculty members are also working with the study.

The survey consists of identifying existing health conditions, need for health services, health resources and health manpower available in the community setting.

The project has the active support of Dr. John R. Copenhaver, Health Officer of Cameron County, who has assisted in the coordination of all field activities and has provided space in the Health Department offices for field staff. Dr. Burgete, Director of the Matamoros, Mexico Health Center has provided detailed support and has been centrally involved in the study. The El Paso Zone Office of the Pan American Health Organization through its director, Dr. Jorge Jimenez-Gandica, has supported and encouraged the study from its inception. Dr. James E. Peavy, Commissioner of Health, Texas State Health Department, is a member of the U.S. -Mexico Border Public Health Association, and has supported both the 1970 and 1971 activities.

Student Qualifications

Forrest Cliff Beavers holds a bachelor's degree in business administration and is currently enrolled for an M.P.H. degree. He has a strong interest in comprehensive health planning and developed a model for comprehensive health planning in a rural community setting. He was invited to participate in the Brownsville survey on the basis of his master's project. He has recently accepted appointment as Associate Director of Comprehensive Health Planning for Rural Health Planning in Bexar County, Texas.

Victoria Moreland, currently enrolled as a candidate for the M.P.H. degree, has had experience in existing community health programs. She holds the B.A. degree cum laude from Rice University. She is interested in evaluation of the effectiveness of community health programs.

Charles Jamison enrolled in an M.P.H. program during the academic year 1970-71 and was awarded that degree in June, 1971. Mr. Jamison was formerly a staff member of the Milk and Dairy Products Division of the Texas State Department of Health. During his academic program he developed several proposed community health studies and successfully completed a master's project entitled "Lead Paint Dangers to Pre-schoolers in Houston, Texas." On the basis of his experience in environmental health, he was invited to participate in the Brownsville survey.

Available Report of Survey

The final project report will be submitted to Houston Endowment, Inc. by April 15, 1972, after an evaluation of the project results has been completed. We will make this report available to the Board of Regents upon its completion. The final report of the El Paso-Juarez, 1970 project will be completed following the final computer runs and data analysis now in progress.

The attached document* is intended to provide additional background. Speaking for the administration of The University of Texas School of Public Health, we are pleased with the 1970 and 1971 U. S. -Mexico Border Health Surveys. We think they will provide a strong factual basis for health planning in an important area of our State, and will be useful in improving health opportunities and health status of residents on both sides of the international boundary.

Please let me know if any further information would be helpful to you or to the members of the Board of Regents.

Sincerely,

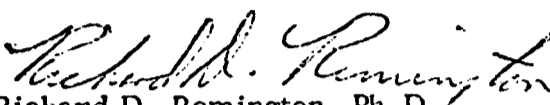
Richard D. Remington, Ph.D.
Associate Dean

RDR/lm

Enclosure

*Document is reproduced below.

Resolution Passed by the United States -Mexico Border
Public Health Association XXIX Annual Meeting, Tucson, Arizona
29 March - 2 April 1971

XI

HEALTH RESOURCES SURVEYS ALONG THE BORDER

WHEREAS the results of the surveys covering health problems and resources and the use of medical services that were carried out in the El Paso-Ciudad Juarez area by medical and public health students of both countries have provided results of great interest, and

WHEREAS these studies can be of use in the training of students of medicine and public health, and

WHEREAS the results obtained can be of use in the improvement of public health services in the border area, be it

RESOLVED that the Association, through its Secretariat, continue to foster the undertaking of such surveys in various border cities.

distributed at the meeting 9/7/71. BAJ

BALLOT

Chancellor's Docket No. 50

Approved except as to the following items:

Regulation Medical Programs of Texas Renewal Grant #5-G03-RM00007-04:

My exception to this is that we are only looking at the operating budget in the amount of \$692,343.00, when the grant consists of almost another million dollars. I think in order for the Regents to give consideration and approval to this that it is mandatory that we see the recipients and amounts of that almost another million dollars.

Under the travel item in this budget, I would like to know who all is traveling where and for what purpose. Since this is a proposed budget for 1971-72, it might be more appropriate to have seen the travel expenditures and what personnel were involved during the 1970-71 period and the purpose of those travels.

Item 63, Page M-9:

Please explain this relationship to TEDTAC and why it is on the Chancellor's Docket instead of the Agenda.

Item 66, Page M-9:

Why bother to put a No. 66 if it is not to be used?

Item 72, Page M-10:

I would like to know the initial funding, since there are no additional funds, and what the Drug Education Project actually consists of.

Item 80, Page M-11:

Please explain what kinds and types of professional personnel are being trained.

(Exceptions continued on attached sheet)

Name Joe T. Nelson
Regent Joe T. Nelson

Date August 27, 1971

Chancellor's Docket No. 50 mailed to each Regent on August 20, 1971.
This ballot should be completed and returned to the Secretary in order that she will receive it by the close of business on September 3, 1971.

Item 32, Page M-11:

Once again, explain the relationship of this item as being on the Chancellor's Docket and not on the Agenda and its relationship to TEDTAC.

Item 25, Page S-7:

Why the transfer of funds in the amount of \$1,376.26, apparently for John W. Schermerhorn, when he just went to work, apparently, on August 23rd?

Extra item under University of Texas Southwestern Medical Branch:

Since this portion of the Chancellor's Docket reflects various changes and amendments to budgets, etc., why has not the transfer and reflection been shown on Mr. Bill F. Jones, Assistant to the Dean, who was assigned half-time to Texas Instruments, while we still show him full-time budgeted through this school in the amount of \$20,000.00 and 100% time to the school?

Related to this matter, find quoted the information I have obtained from Washington:

"HSMHA has a contract with Texas Instruments in Dallas, Texas to provide within 12 months, a model plan for the development of an industry based HMO in cooperation with a medical school.

The HMO Office in HSMHA has become aware that there is state legislation regulating the establishment of HMO's. I am informed that the attorneys for Texas Instruments, the medical school involved, and the HEW regional office are having discussions on this subject and, it has not yet been determined whether or not the state law will prevent Texas Instruments from carrying out the contract. The contracting officer is not aware of any plans to shift the contract from Texas Instruments Dallas office to their California office."

Item 6, Page ST-5:

Please explain to me if this is Dr. Arney's first approval for a tenure and why is an endocrinologist necessary to be the acting director of the O.E.O. Project, Grant #6810, when this basically is a research and pilot project in family practice.

Item 9, Page St-5:

Why the recommendation for re-appointment of Dr. Lloyd F. Berry when apparently the decision to dismiss him had been made prior to the August 9th dating of this report to the Chancellor? In addition, why had the Board not approved his tenure and why was he coerced into signing the letter of resignation?

Item 10, Page ST-5:

Re-appoint Dr. Douglas when he has just come aboard approximately two months ago and who tells me personally that he has tenure, and I have not seen this in any of our data?

Extra Item:

Why were the Regents not asked to approve the funding and renewal of the O.E.O. Grant application of the University of Texas Medical School at San Antonio? It was missing from the Chancellor's Docket #49, which was up for our approval at the Board of Regents Meeting on July 30th.

Item 5, Page G-12:

Why is it necessary to appoint Dr. Charles B. McCall as Professor without tenure part-time, without salary, effective July 1, 1971, when he is full time RMP and apparently does not have the part-time to spare?

Items 2, 3 & 4, Page PH-5:

These three students I would question as if they were the Ralph Nadar type people. At whose invitation did they conduct the survey, i. e. your local county medical society, the local health department, the state public health department, or who?

Secondly, their qualifications (since apparently they are not MD's) to conduct such a survey?

Thirdly, I would like to see the report of such a survey and have it made available to the Regents.

Jas. Nelson MD?

REGIONAL MEDICAL PROGRAM OF TEXAS

Renewal Grant No. 5-G03-RM00007-04 for the period September 1, 1971 through August 31, 1972 from the U. S. Department of Health, Education, and Welfare for the Regional Medical Program of Texas has been awarded in the amount \$1,590,000, with an initial allocation of \$1,274,565. Program awards to component institutions will be reflected in subsequent dockets of the receiving institution. The 1971-72 operating budget for the Office of the Coordinator follows.

REGIONAL MEDICAL PROGRAM OF TEXAS
Office of the Coordinator
Operating Budget, 1971-72

Administrative and Professional Salaries	\$ 228,700
Classified Salaries	73,512
Unallocated Salaries	175,582
O.A.S.I. Matching	<u>20,000</u>
Sub-total	<u>497,794</u>
Maintenance and Operation	120,479
Equipment	5,670
Travel	56,400
Computer and Data Processing Costs	<u>12,000</u>
Total Budget, 1971-72	<u>\$ 692,343</u>

SALARY ROSTER:

Supplemental Data		Item No.	Title - Name - Code	1971-72			1970-71	1971-72	
1970-71	1971-72			Appointment Period	% Time	Mos.	Adjusted Rate	Amount	
			COORDINATOR; ASSISTANT VICE CHANCELLOR REGIONAL MEDICAL PROGRAMS; PROFESSOR OF MEDICINE, GALVESTON MEDICAL BRANCH	1000					
		1.	Charles B. McCall	9-01	8-31	100	12	\$ 35,000	\$ 37,500
			DIRECTOR OF PROFESSIONAL PROGRAMS	1000					
\$27,900	\$19,000	2.	Stanley Burnham	9-01	5-31	46			
				6-01	8-31	100			19,000
			U.T. Austin:						
2,100	11,000		Physical Instruction	9-01	5-31	50			
1,000	1,000		Athletic Council	9-01	5-31	4			
<u>\$31,000</u>	<u>\$31,000</u>		Total Salary			100	12		
			DIRECTOR OF COMMUNITY HEALTH ORGANIZATION AND MEDICAL CONSULTANT	1000					
		3.	Ross L. McLean	9-01	10-31	LWOP	---		---
			DIRECTOR OF PROGRAM MANAGEMENT AND DEPUTY COORDINATOR	1000					
		4.	David K. Ferguson	9-01	8-31	100	12	20,000	22,500

REGIONAL MEDICAL PROGRAM OF TEXAS (Continued)

SALARY ROSTER:

Supplemental Data		1971-72		1971-72		1970-71		1971-72		
1970-71	1971-72	No.	Title - Name - Code	Appointment Period	% Time	Mos.	Adjusted Rate	1971-72 Amount		
			DIRECTOR OF COMMUNITY HEALTH PROGRAMS	1000						
		5.	Nathaniel D. Macon	9-01 8-31	100	12	\$ 21,500	\$ 22,500		
			CHIEF OF EVALUATION AND DATA MANAGEMENT	1000						
		6.	Robert O. Humble	9-01 8-31	100	12	17,500	18,500		
			CHIEF OF ADMINISTRATIVE SERVICES	1000						
		7.	Mary Louise W. Miller	9-01 8-31	100	12	16,000	17,000		
			REGIONAL REPRESENTATIVE	1000						
		8.	John L. Oxley	9-01 8-31	100	12	15,000	15,000		
		9.	Marian M. Strohmeier	9-01 8-31	100	12	13,000	13,500		
		10.	Henry G. Faulk, Jr.	9-01 8-31	100	12	12,000	13,000		
		11.	Maria E. A. Flood	9-01 8-31	100	12	11,000	12,000		
			EVALUATION SPECIALIST	1000						
		12.	Hubert D. Reese	9-01 8-31	100	12	12,500	13,500		
			INFORMATION OFFICER	1000						
		13.	Beverly A. Drawe	9-01 8-31	100	12	12,000	12,700		
			OPERATIONS OFFICER	1000						
		14.	Robert L. Anderson	9-01 8-31	100	12	11,500	12,000		
			TOTAL - ADMINISTRATIVE SALARIES						\$228,700*	
			RMP FISCAL OFFICER	9157						
		15.	Thomas V. Sanders	9-01 8-31	100	12	\$ 10,020	\$ 10,920		
			SOCIAL SCIENCE RESEARCH ASSOCIATE II	4008						
		16.	Darlene T. Gouge	9-01 8-31	100	12	8,520	8,520		
			ADMINISTRATIVE SECRETARY	9040						
		17.	Carolyn A. Caldwell	9-01 8-31	100	12	6,780	6,780		
		18.	Margaret W. Francis	9-01 8-31	100	12	6,168	6,468		
		19.	Sharmon S. Kaiser	9-01 8-31	100	12	5,784	6,168		
		20.	Georgia Ann Roberts	9-01 8-31	100	12		6,168		

REGIONAL MEDICAL PROGRAM OF TEXAS (Continued)

SALARY ROSTER:

Supplemental Data		No.	Title - Name - Code	1971-72 Appointment Period		% Time	Mos.	1970-71	1971-72	
1970-71	1971-72			Adjusted Rate	Amount					
			SENIOR SECRETARY	9041						
		21.	Elizabeth C. Kennedy	9-01	8-31	100	12	\$ 5,520	\$ 5,784	
		22.	Barbara J. Moran	9-01	8-31	100	12	5,028	5,268	
		23.	Marillyn A. Nesbitt	9-01	8-31	100	12	5,028	5,268	
		24.	Karen J. Walsh	9-01	8-31	100	12	5,784	5,784	
			CLERK-TYPIST	9054						
		25.	Rebecca J. Arnold	9-01	8-31	37.5		1,719	1,800	
\$ 4,584#	\$ 4,800#		Classified Rate			100	12			
			STATISTICAL CLERK I	9221						
		26.	Leslie M. Lee	9-01	8-31	100	12	4,392	4,584	
			TOTAL - CLASSIFIED SALARIES							\$ 73,512*

Sincerely,

Charles A. LeMaistre /a.

Charles A. LeMaistre, M.D.
Chancellor

59. Change Order No. 1 to Contract No. 14-10-7:931-43, by which the U. S. Department of the Interior, National Park Service, Southwest Archeological Center, Globe, Arizona, provides \$5,000 additional funds and increases the total contract amount to \$10,000 for test excavations at selected archeological sites at Amistad Reservoir, Texas. The project continues under the direction of Dr. David S. Dibble, Acting Director, Texas Archaeological Salvage Project.
60. Contract No. 82-48-71-38, by which the U. S. Department of Labor, Manpower Administration, Washington, D. C. , provides \$100,000 for support of a pilot project to overcome barriers to employment of minority women in white collar jobs. The contract is effective for the period June 21, 1971 through September 20, 1972, and the project will be under the direction of Dr. F. Ray Marshall, Professor of Economics.
61. Grant CG-6611 A/O, by which the Office of Economic Opportunity, Washington, D. C. provides \$73,647 for support of research entitled, "Planning for Growth and Development in Rural Areas in the Context of a National System of Regions." The grant is effective for the period June 1, 1971, through December 31, 1971, and the research will be under the direction of Dr. Niles M. Hansen, Professor of Economics.
62. Grant Action No. 1 to Grant CG-6994, by which the Office of Economic Opportunity, Washington, D. C. , provides \$100,000 additional funds and extends the period of the grant through August 31, 1972. The program entitled, "Labor Market Research Strategy," continues under the direction of Dr. F. Ray Marshall, Professor of Economics.
63. Modification No. 2, Supplemental Agreement to Contract OEC-7-70-0187-(211), by which the Department of Health, Education, and Welfare, Office of Education, Dallas, Texas, increases the contract funds by \$245,076 and extends the period of the contract through June 30, 1972. Revised proposal for period July 1, 1971 through June 30, 1972, approved by Office of Education on August 6, 1971. The program entitled, "Establishment of a Consultant Center for Educational Leaders in Texas Concerned with Problems of Desegregation," continues under the direction of Dr. W. E. Barron, Professor of Educational Administration.
64. Contract OEC-0-71-3181-(821), by which the Department of Health, Education, and Welfare, Office of Education, Washington, D. C. , provides \$33,856 for the continuation of the Center for Middle Eastern Studies. The contract is effective for the period July 1, 1971 through June 30, 1972, and the Center will be under the direction of Dr. Paul W. English, Professor of Geography.
65. Contract OEC-0-71-3188(821), by which the Department of Health, Education, and Welfare, Office of Education, Washington, D. C. , provides \$23,989 for support of the Center for Asian Studies. The contract is effective for the period July 1, 1971 through June 30, 1972, and the Center will continue under the direction of Dr. E. G. Polome, Professor of Germanic Languages and of Linguistics, and of Oriental and African Languages and Literatures.
66. This number will not be used.

67. Contract OEC-0-71-3438(821), by which the Department of Health, Education, and Welfare, Office of Education, Washington, D. C. provides \$39,050 for continuation of the Language and Area Center for Latin American Studies. The contract is effective for the period July 1, 1971 through June 30, 1972, and the Center will continue under the direction of Dr. William P. Glade, Professor of Economics.
68. Contract OEC-6-71-0561-(508), by which the Department of Health, Education, and Welfare, Office of Education, Washington, D. C., provides \$12,000 for support of research entitled, "The Politics of Bilingual Education." The contract is effective for the period June 1, 1971 through May 31, 1973, and the research will be under the direction of Dr. Robert L. Hardgrave, Jr., Associate Professor of Government.
69. Contract OEC-6-71-0526(508), by which the Department of Health, Education, and Welfare, Regional Office, Dallas, Texas, provides \$12,000 for support of research entitled, "Conceptions of Democratic Education in the Founding of the French Third Republic (1870-c.1905)." The contract is effective for the period June 1, 1971 through May 31, 1973, and the research will be under the direction of Dr. J. Stephen Hazlett, Assistant Professor of Cultural Foundations of Education.
70. Contract OEC-6-71-0531(509), by which the Department of Health, Education, and Welfare, U.S. Office of Education, Regional Office, Dallas, Texas, provides \$7,476 for support of research entitled, "Experimental Curriculum Units in Government and Political Alienation: A Study in Political Socialization of Anglo, Black, and Mexican-American Adolescents." The contract is effective for the period June 1, 1971 through May 1, 1972, and the research will be under the direction of Dr. O. L. Davis, Jr., Professor of Curriculum and Instruction.
71. Revision No. 5 to Grant OEG-0-70-1878(715), by which the Department of Health, Education, and Welfare, Office of Education, Washington, D.C., increases funds by \$76,532 and extends the period of the grant through August 31, 1971. The program entitled, "Teacher Corps Intervening Summer Training," continues under the direction of Dr. David Ballesteros, Associate Professor of Curriculum and Instruction.
72. Revision No. 2 to Grant OEG-0-70-2152(725), by which the Department of Health, Education, and Welfare, Office of Education, Washington, D. C., extends the period of the grant through December 30, 1971, without additional funds. The Drug Education Training Project is coordinated by Fred S. Brinkley, Assistant to the Dean, College of Pharmacy.
73. Grant OEG-0-71-3625, by which the Department of Health, Education, and Welfare, Office of Education, Washington, D.C., provides \$62,700 for support of research entitled, "Multi-disciplinary Graduate Program for Preparation of Educational Research Specialists." The grant is effective for the period June 1, 1971 through August 31, 1972, and the research will be under the direction of Dr. Jackson B. Reid, Professor of Educational Psychology.
74. Grant OEG-0-71-0223-(824-820), by which the Department of Health, Education, and Welfare, Office of Education, Washington, D. C., provides \$22,115 (\$9,681 in U.S. Dollars, \$5,300 equivalent in Indian Rupees, and \$7,134 equivalent in Moroccan Dirhams) for support of Doctoral Dissertation Research Abroad. The grant is effective for the period July 1, 1971 through February 28, 1973, and the program will be coordinated by Dr. Fred P. Ellison, Associate Dean of the Graduate School.

75. Amendment No. 1 to Grant OEG-0-71-0223-(824-820), by which the Department of Health, Education, and Welfare, Office of Education, Washington, D. C., provides \$8,200 additional funds for support of the program, "Doctoral Dissertation Research Abroad," which continues to be coordinated by Dr. Fred P. Ellison, Associate Dean of the Graduate School.
76. Amendment No. 2 to Grant OEG-0-71-0223-(824-820), by which the Department of Health, Education, and Welfare, Office of Education, Washington, D. C., increases funds by \$6,225 to a new total of \$36,540 for support of the program, "Doctoral Dissertation Research Abroad," which continues to be coordinated by Dr. Fred P. Ellison, Associate Dean of the Graduate School.
77. Grant Agreement OEG 0-71-0317-(820), by which the Department of Health, Education, and Welfare, Office of Education, Washington, D. C., provides \$24,485 (\$13,055 equivalent in Moroccan dirhams and \$11,430 equivalent in Indian rupees) for support of faculty research abroad. The grant is effective for the period July 1, 1971 through February 28, 1973, and the program will be coordinated by Dr. Fred P. Ellison, Associate Dean of the Graduate School.
78. Grant OEG-0-71-0704(807), by which the Department of Health, Education, and Welfare, Office of Education, Institute of International Studies, Washington, D. C., provides \$13,000 for support of 20 teachers of English from other countries during the fall semester of 1971. The grant is effective for the period September 4, 1971 through December 18, 1971, and the program will be under the direction of Dr. Joe W. Neal, Professor of Speech, and Director, International Office.
79. Grant OEG-0-71-1069-(725), by which the Department of Health, Education, and Welfare, Office of Education, Washington, D. C., provides \$60,763 for support of research entitled, "National Program for Educational Leadership." The grant is effective for the period May 28, 1971 through June 30, 1972, and the research will be under the direction of Dr. Michael P. Thomas, Associate Professor of Educational Administration.
80. Grant OEG-0-71-1633(603), by which the Department of Health, Education, and Welfare, Office of Education, Washington, D. C., provides \$491,900 for support of a program entitled, "Training of Professional Personnel in the Education of the Handicapped." The grant is effective for the period June 1, 1971 through August 31, 1972, and the program will be under the direction of Dr. Jasper Harvey, Professor of Special Education.
81. Grant OEG-0-71-4471(603), by which the Department of Health, Education, and Welfare, Office of Education, Washington, D. C., provides \$257,575 for support of a project entitled, "Staff Training for Exemplary Early Childhood Centers for Handicapped Children." The grant is effective for the period June 30, 1971 through June 29, 1972, and the project will be under the direction of Dr. Jasper Harvey, Professor of Special Education.
82. Revision #2 to Grant OEG-7-70-0184-(209), by which the Department of Health, Education, and Welfare, Office of Education, Washington, D. C., increases grant funds by \$330,365 to a new total of \$890,895 and extends the period of the grant through June 30, 1972. The program entitled, "The Establishment of a Series of Institutes for Educational Leaders in Texas Concerned with Problems of School Desegregation," continues under the direction of Dr. W. E. Barron, Professor of Educational Administration.

RECOMMENDED AMENDMENTS TO 1970-1971 BUDGET. - continued

Physical Plant

22. Transfer funds in the amount of \$1,005.20, as follows: From Custodial Services Equipment, account No. 223007, \$118.00; Grounds Maintenance Equipment account No. 224007, \$407.20; Utilities Equipment, account No. 225007, \$480.00; to General Services Equipment account No. 221007, \$1,005.20. (RBC No. 340)

Special Projects

23. Transfer funds in the amount of \$11,000 from Unallocated Maintenance and Operation, account No. 207005, to Special Projects - Temporary Parking Lot, account No. 231405. (RBC No. 362)

24. Transfer funds in the amount of \$14,000 from Unallocated Maintenance and Operation, account No. 207005, to Special Projects - Campus Lighting, account No. 231305. (RBC No. 378)

School of Allied Health Professions

25. Transfer funds in the amount of \$1,376.26 from Unallocated Faculty Salaries, account No. 207000, to School of Allied Health Professions Administrative and Professional Salaries, account No. 250001, and appoint John W. Schermerhorn, Dean and Professor of School of Allied Health Professions, at an annual salary rate of \$32,000 payable from School of Allied Health Professions General Budget. (RBC No. 385)

Respectfully submitted,

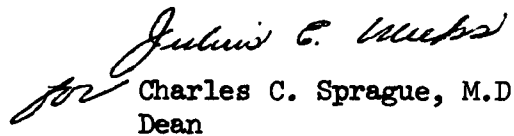
for Charles C. Sprague, M.D.
Dean

Anatomy

3. Change the source of funds of Dr. Gene L. Colborn, Assistant Professor at an annual salary rate of \$18,500, from Anatomy, Teaching Salaries to DHEW Grant 2 R01 NS06980-05 effective July 1, 1971. Transfer unused Teaching Salaries of \$3,083.34 to Unallocated Faculty Salaries. (RBC 207)

Biochemistry

4. Change the status of Dr. David M. Shapiro from Assistant Professor (100% time) to Assistant Professor (55% time) effective July 1, 1971. Transfer unused Teaching Salaries in the amount of \$1,650.00 to Unallocated Faculty Salaries. Dr. Shapiro will also be paid as Assistant Professor (45% time) from DHEW Grant 1 DO8 ME00138-01. (RBC 203)

5. Appoint Dr. David M. Shapiro as Assistant Professor (45% time) at an annual salary rate of \$22,000 effective July 1, 1971. Dr. Shapiro will also be paid as Assistant Professor (55% time) from the Department of Biochemistry, Teaching Salaries. (RBC 204)

Medicine

6. Reappoint Dr. Glen Keith Arney as Associate Professor (T) at an annual salary rate of \$22,000 effective July 1, 1971. Funds needed for this reappointment to come from DHEW Grant 5 E03 ME00172-05. (RBC 210)

7. Reappoint Dr. Samuel J. Friedberg as Professor (T) at an annual salary rate of \$25,000 effective July 1, 1971. Funds needed for this reappointment to come from DHEW Grant 5 KO4 HE08366-05. (RBC 212)

8. Appoint Miss Myra A. Lappin as Instructor (Health Care Administration) at an annual salary rate of \$10,100 effective July 1, 1971. Funds needed for this appointment to come from OEO Grant B/O. (RBC 216)

9. Reappoint Dr. Lloyd E. Berry as Associate Professor at an annual salary rate of \$25,400 effective July 1, 1971. Funds needed for this reappointment to come from OEO Grant 6810 B/O. (RBC 221)

10. Reappoint Dr. Herschel L. Douglas as Associate Professor at an annual salary rate of \$25,400 effective July 1, 1971. Funds needed for this reappointment to come from OEO Grant 6810 B/O. (RBC 222)

11. Reappoint Mr. Robert O. Whitmore as Assistant Professor at an annual salary rate of \$18,000 effective July 1, 1971. Funds needed for this reappointment to come from OEO Grant 6810 B/O. (RBC 230)

Microbiology

12. Change the effective appointment date of Dr. Daniel E. Thor, Associate Professor (T) at an annual salary rate of \$23,000, from June 1, 1971 to August 1, 1971. Transfer unused teaching salaries in the amount of \$3,833.34 to Unallocated Faculty Salaries. (RBC 231)

Pediatrics

13. Reappoint Dr. Eleanor A. Eller as Assistant Professor (16.67% time) at an annual salary rate of \$20,000 effective July 1, 1971. Funds needed for this reappointment to come from DHEW Grant 5 E03 ME00172-05. (RBC 209)

Psychiatry

14. Reappoint and change the percent time of Dr. Alberto C. Serrano Associate Professor (40% time - without tenure) to Associate Professor (80% time - without tenure) at an annual salary rate of \$28,000 effective July 1, 1971. Funds needed for this reappointment and change to come from DHEW Grant 1 T01 MH12651-01. (RBC 215)

RECOMMENDED AMENDMENTS TO 1970-71 BUDGET

Instruction and Departmental Operations

Anesthesiology

1. Grant a Leave of Absence without salary to Dr. Cecil Khoury, Instructor, at a salary rate of \$12,000 for 12 months (\$4,000 from General Budget and \$8,000 from Shrine Affiliation Agreement, effective June 20, 1971. (RBC 505)

2. Accept the resignation of Dr. Juan Leal, Clinical Instructor, part-time, without salary, effective June 30, 1971. (RBC 525)

Human Genetics

3. Appoint Dr. Harrol T. Hutchinson as Assistant Professor at a salary rate of \$19,000 for 12 months, effective July 1, 1971. Funds needed are to come from Unallocated Appropriations - Instructional. (RBC 517)

Internal Medicine

4. Increase the salary rate of Dr. Marcel Patterson, Professor, from \$25,500 for 12 months from General Budget to \$27,000 for 12 months (\$6,750 from General Budget and \$20,250 from DHEW Grant No. 3D08-ME-00131-02SL), effective June 1, 1971. (RBC 459)

5. Appoint Dr. Charles B. McCall as Professor, without tenure, part-time, without salary, effective July 1, 1971. (RBC 466)

6. Accept the resignation of Dr. Louis F. Kuehn, Senior Research Fellow in Immunology, at a salary rate of \$16,573 for 12 months, effective June 9, 1971. (RBC 475)

7. Appoint Dr. James A. Reinartz as Associate Professor at a salary rate of \$26,000 for 12 months, effective July 15, 1971. Funds needed are to come from Unallocated Appropriations - Instructional. (RBC 492)

8. Change the source of funds for Dr. Phillip L. Poffenbarger, Assistant Professor at a salary rate of \$20,000 for 12 months from \$10,000 from General Budget and \$10,000 from DHEW Grant No. 5 E03-ME-00170-05 to General Budget only, effective July 1, 1971. Additional funds needed are to come from Unallocated Appropriations - Instructional. (RBC 520)

9. Accept the resignation of Dr. George D. Cain, Instructor, at a salary rate of \$17,000 for 12 months, effective June 30, 1971. (RBC 521)

10. Change the status of Dr. James D. Lindley from Instructor and Chief Resident, part-time, at a salary of \$2,800 for 12 months (\$2,500 from General Budget and \$300 from MSRDP - Internal Medicine) to full-time at a salary rate of \$20,000 for 12 months (\$2,500 from General Budget, \$10,000 from DHEW Grant PH-86-67-238 and \$7,500 from Artificial Kidney Renal Fund), effective July 1, 1971. (RBC 522)

11. Appoint Dr. Akira Nishimura as Instructor at a salary rate of \$12,200 for 12 months (\$2,200 from General Budget and \$10,000 from SRA Grant No. 13-P-55236/6-02), effective July 1, 1971. General Budget Funds needed are to come from Unallocated Appropriations - Instructional. (RBC 529)

23. Change in Time Assignment: Change the time assignment of Dr. Stanley M. Pier, Adjunct Associate Professor of Environmental Health, Institute of Environmental Health, from fifty percent time at the rate of \$12,500.00 per annum from Institute of Environmental Health (General Funds) to full-time payable at the rate of \$25,000.00 per annum, \$12,500.00 per annum from Institute of Environmental Health (General Funds) and \$12,500.00 per annum from NASA Contract NAS 9-11701, effective July 1, 1971. (RBC 104)

ABSENCES FROM USUAL AND REGULAR DUTIES: The following absences from usual and regular duties for periods in excess of 29 days have been approved by the Dean and the Chancellor. I recommend your approval and presentation to the Board of Regents for final approval.

1. Dr. George M. Walker, Jr., Associate Professor of Health Services Administration, for the period July 6, 1971 through September 10, 1971, to Brownsville and El Paso, Texas; Matamoros, Ciudad Juarez, Ciudad Chihuahua, and Tampico, Mexico, where he will conduct community survey research in health needs, resources, and utilization in cooperation with medical schools in Tamaulipas and Chihuahua, Mexico.
2. Cliff Beavers, Student, for the period July 6, 1971 through September 10, 1971, to Brownsville, Texas and Matamoros, Mexico, to conduct community survey research in health needs.
3. Vicki Moreland, Student, for the period July 6, 1971 through September 10, 1971, to Brownsville, Texas and Matamoros, Mexico, to conduct community survey research in health needs.
4. Charles S. Jamison, Student, for the period July 6, 1971 through September 10, 1971, to Brownsville, Texas and Matamoros, Mexico, to conduct community survey research in health needs.
5. Sara A. Barton, Research Associate, for the period July 6, 1971 through September 4, 1971, to Brownsville, Texas and Matamoros, Mexico, to conduct community survey research in health needs.
6. Florence Lee, Research Associate, for the period July 6, 1971 through September 4, 1971, to Brownsville, Texas and Matamoros, Mexico, to conduct community survey research in health needs.
7. Dr. Darwin R. Labarthe, Associate Professor of Epidemiology, for the period August 5, 1971 through September 8, 1971, to Oslo, Norway, for a meeting regarding teaching and research programs in nutrition and heart disease; Skovda, Sweden, to attend a seminar in cardiovascular epidemiology; Geneva, Switzerland and Copenhagen, Denmark, to meet with various officials with the World Health Organization; Boston, Massachusetts for a meeting concerning the Boston Clinical Center for Hypertension Control.
8. Dr. Richard D. Remington, Associate Dean for Research and Professor of Biometry, for the period July 26, 1971 through August 30, 1971, to Rockville, Maryland to consult with Dr. Elijah White at the National Center for Health Statistics; London, England for a meeting at the London School of Hygiene and Tropical Medicine; then to Goteborg, Sweden to teach a course entitled "Ten Days of Cardiovascular Epidemiology Seminar."

Respectfully submitted,

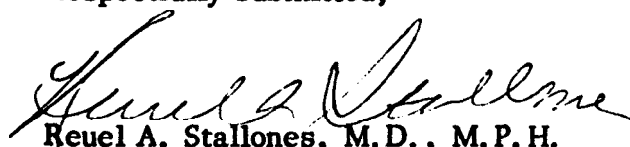
Reuel A. Stallones, M.D., M.P.H.
Dean

1. U. T. System: Chancellor's Docket No. 50. --Chancellor's Docket No. 50 was mailed by the Secretary to each member of the Board of Regents on Friday, August 20, 1971. The ballots are due in the Secretary's Office at the close of business on September 3, 1971. If there are exceptions to the docket they will be reported at the meeting of the Academic and Developmental Affairs Committee and referred to the Committee of the Whole for consideration. Otherwise, the docket will be presented for formal approval.

2. U. T. Austin: Approval of Model Affiliation Agreement for College of Pharmacy and Approval for the Execution of Such Agreement with Seton Hospital, Austin. --(Pages 2-6)

At the meeting of the Board of Regents on October 23, 1970, consideration was given to a model affiliation agreement to be used by the College of Pharmacy at The University of Texas at Austin. There was opposition to the agreement, and the Chairman appointed a regental committee composed of Regents Garrett, Kilgore, and Peace to make and approve such changes as they deemed necessary. The committee has now approved the agreement, and it is herewith submitted for approval by the Board. (Pages 3-6)

This proposed agreement has been negotiated between the College of Pharmacy and Seton Hospital, and will permit students of the University to engage in clinical pharmacy under the direct supervision and responsibility of the faculty of the University.

System Administration concurs in the recommendation of The University of Texas at Austin that the model agreement and the proposed agreement with Seton Hospital be, in all things, approved, and that the Chairman of the Board be authorized to execute the Seton Hospital agreement. When negotiated, other affiliation agreements based upon this model agreement will be submitted to the Board of Regents for ratification and authorization for the Chairman to execute.

*Relax E.
Jan E. 2x*

AFFILIATION AGREEMENT

THE STATE OF TEXAS)
 (
COUNTY OF TRAVIS)

This AGREEMENT is executed on _____, 1971, between the BOARD OF REGENTS OF THE UNIVERSITY OF TEXAS SYSTEM, for and on behalf of the College of Pharmacy of The University of Texas at Austin, hereinafter sometimes referred to as "University" in this agreement, and _____, hereinafter sometimes referred to as "Facility" in this agreement, WITNESSETH:

WHEREAS, it is agreed by the parties to be of mutual interest and advantage that the students and faculty of the University be given the opportunity to utilize the Facility as a practice laboratory and for educational purposes:

NOW, THEREFORE, for and in consideration of the foregoing, and in further consideration of the mutual benefits, the parties to this agreement agree as follows:

(1) The Facility will permit students of the University to engage in clinical pharmacy clerkships under the direct supervision and responsibility of the faculty of the University. The individual faculty members will be responsible to the liaison person designated by the Facility for all general arrangements relating to student clerkships.

(2) The number and distribution of students between the divisions of the Facility will be mutually agreed upon between the University and the Facility at the beginning of each semester.

(3) The period of assignment shall be during regular University academic sessions, except in the instance of special arrangements, such as for workshop participants.

(4) The University will provide the Facility with the names of the students who are entitled to use the resources of the Facility under the terms of this agreement.

(5) Representatives of the University and the Facility shall meet as often as necessary to study the clerkship program and terms of this agreement and make such suggestions and changes as are needed.

(6) University personnel, faculty, and students will be subject to the rules and regulations established by the Facility for the division of the Facility to which they are assigned:

- (A) the Facility will charge the University no fees for general supervision of clerkships provided for students;
- (B) students will be responsible for their own meals, laundry, and transportation to and from the Facility;
- (C) the University will be responsible for the students' health needs while in the performance of this agreement; and
- (D) the Facility will not be charged for services performed by University personnel or students.

(7) Only insofar as it is authorized by law to do so, the University agrees to hold the Facility harmless from and against any and all liability for personal injury, including injury resulting in death, or damage to property, or both, resulting ~~directly or indirectly~~ from the use by the University of the Facility, and agrees to reimburse the Facility for all reasonable expenses, including attorney's fees, incurred by the Facility in defending any such claim or claims.

(8) The salaries and expenses of any instructors, supervisors, or other employees of the University will be paid by the University. The University agrees that members of its faculty will serve as consultants and on committees of the Facility when requested by the Facility.

(9) The Facility further agrees as follows:

- (A) to maintain the criteria for accreditation as established by the Joint Commission on Accreditation of Hospitals, or other appropriate accrediting agency;
- (B) to provide to the University the necessary space or facilities for conference and classroom areas for student teaching, as available;
- (C) to provide lounge and locker space for students of the University, as available; and
- (D) to allow students and faculty members of the University to utilize the Facility's eating facilities at the students' and faculty's sole expense.

(10) This agreement is for a term of one year, and thereafter from year to year unless terminated by either party upon giving six months' advance notice to the other party by certified mail.

EXECUTED by the parties on the day and year first above written.

ATTEST:

BOARD OF REGENTS OF THE
UNIVERSITY OF TEXAS SYSTEM

Secretary

By _____
Chairman

ATTEST:

FACILITY

By _____

Approved as to Form:

Approved as to Content:

University Attorney

Deputy Chancellor for
Administration

Vice-Chancellor for Health
Affairs

3. U. T. Austin: Reconstitution of the Athletics Council. -- (Pages 7-10)

Chancellor LeMaistre concurs in President Spurr's recommendation to reject the Faculty Senate's proposal to reconstitute the Athletics Council at U.T. Austin. The proposal recommended by the U.T. Austin faculty is attached as well as Dr. Jordan's summary of the proposal and its effects. The reasons for recommending rejection are stated in Dr. Jordan's June 4, 1971 letter, and President Spurr, after reviewing the matter, endorses his recommendations that the proposal be rejected.

Following is Dr. Spurr's letter of July 29:

Charles A. LeMaistre, M.D.
Chancellor
The University of Texas System

Dear Dr. LeMaistre:

On July 8, 1971, Vice-Chancellor Ashworth returned for my consideration the letter sent to you on June 4 by President Jordan, outlining his position on the University Council's action concerning reconstitution of the Athletics Council. I appreciate the opportunity extended to me to participate in the consideration of this particular issue.

While I am aware of the substantial differences of opinion that exist within our faculty and student body with respect to the role and composition of the Athletics Council, I am convinced that President Jordan's position was based on a thorough analysis and review of this matter as it evolved during the past year. I have no basis for questioning his judgement at this time. Thus, it seems most appropriate for me to endorse his recommendations and to resubmit them to you along with the University Council's action.

In taking this particular position, may I also indicate my intention to subject this general issue to further review, accompanied by appropriate consultation both with student government leaders, official faculty bodies, and individual members of the faculty during the coming year. A re-evaluation of the entire committee structure at The University of Texas at Austin is already underway and the results of these efforts may well include the subsequent submission of recommendations affecting the standing faculty committee on Intercollegiate Athletics and the Athletics Council.

Sincerely yours,



Stephen H. Spurr

SHS/gp
cc: Dr. J. Neils Thompson
Dr. Forest Hill
Attachment

Following is Dr. Jordan's letter of June 4:



THE UNIVERSITY OF TEXAS AT AUSTIN
OFFICE OF THE PRESIDENT
AUSTIN, TEXAS 78712

CHANCELLOR'S OFFICE U. of T.

Acknowledged..... File.....

REC'D JUN 7 1971

.....For Info and Return

To..... Please Advise Me

To.. Please Handle

President

June 4, 1971

Charles A. LeMaistre, M. D.
Chancellor
The University of Texas System
Commodore Perry Building 1104

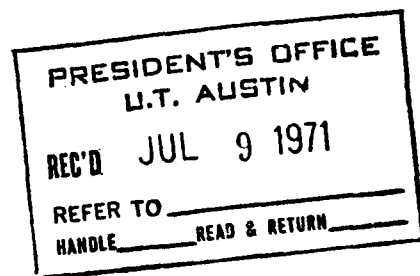

Dear Dr. LeMaistre:

On March 15, 1971, the University Council adopted a recommendation of the Faculty Senate concerning reconstitution of the Athletics Council. That recommendation may be found in the attached document forwarded to me by Dr. Forest Hill, Secretary of the University Council

As currently organized, the Athletics Council consists of the following:

- (1) Five members of the faculty, four of whom are appointed for four-year staggered terms, plus the Council's chairman whose tenure is indefinite. These five individuals (actually six during the past year) also constitute the standing Committee on Intercollegiate Athletics at The University of Texas at Austin.
- (2) One student representative, selected by the President of the Students' Association, who serves for a period of one year.
- (3) One representative of the Ex-Students' Association.
- (4) Two Regental appointees selected by the Board of Regents.

In addition, the Athletic Director also serves on the Council in a non-voting position.

The recommendations of the University Council would alter the Athletics Council in the following ways.

- (1) The number of student representatives would be increased to three, the appointments for each of whom would be lengthened to two years.
- (2) The two appointees from the Board of Regents would be eliminated from the Council.
- (3) A two-year term of office for the representative of the Ex-Students' Association would be instituted, with

an election to be held by the Association at the end of each two-year term.

- (4) The five faculty members would be elected by the Faculty Senate for five-year terms and the chairman would be elected annually by the members of the Athletics Council.

While none of these recommended changes appear to me to be particularly beneficial, I especially find the last to be objectionable. Essential to the fulfillment of the Council's policy making and administrative responsibilities is an effective relationship between the President, the Chairman of the Athletics Council, and the Athletic Director. It would be administratively inappropriate if not disruptive were the power of appointing the chairman to be vested in any office or body other than the President. Furthermore, since the Athletics Council chairman serves as the University's representative to the Southwest Conference and the NCAA, the person occupying this position should never be without the full faith and authority of the Office of the President. The chairman's representation before these groups often involves extremely complicated issues, many of which are matters that are negotiated over relatively long periods of time. Thus, in addition to retaining the power of appointment, the President of The University of Texas at Austin, and the University itself, would be dis-served were the chairman prevented in any procedural way from serving longer than one year.

The rules of both the Southwest Conference and the NCAA require that our Athletics Council be dominated by faculty membership. To fulfill this requirement, any increase in the number of students, as called for by the University Council, would eliminate one or both of the current Regental appointees. While I see no disadvantage to increasing the number of students on the Council, I correspondingly see no advantage to eliminating the appointees of the Board of Regents.

Similarly unacceptable is the recommendation that the faculty members on the Athletics Council be elected directly by the Faculty Senate rather than appointed by the President. Should such an election by the Faculty Senate produce an Athletics Council composed of individuals whose convictions about the role of intercollegiate athletics are in any major way inconsistent with those of the University administration, undesirable deadlocks could easily occur. The President should be able to retain the degree of appointment power that his office has possessed in the past. Should the faculty or the student body of the University have fundamental disagreements with the operations and objectives of our intercollegiate athletics program, adequate administrative channels exist for those disagreements to be aired, discussed, and reconciled.

Thus, the recommendations of the University Council on this matter are hereby forwarded to you without my endorsement. While some changes in the composition of the Athletics Council could conceivably be beneficial to The University of Texas at Austin, the extent and scope of the University Council's recommendations do not seem to me to be consistent with the improvements we always seek.

Sincerely yours,

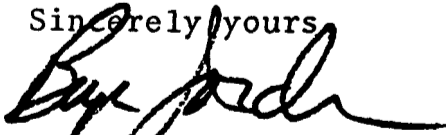

Bryce Jordan
President ad interim

BJ:jt

cc: Dr. Forest Hill
Dr. Stephen Spurr

REC'D MAR 18 1971

PROPOSED MEMBERSHIP OF THE ATHLETICS COUNCIL

REFER TO _____
HANDLE _____ READ & RETURN _____

The Faculty Senate has filed with the Secretary of the University Council the recommendation, set forth below, which was adopted by the Senate on March 8, 1971. The Secretary has classified this proposal to be minor legislation.

Notice is hereby given that this legislation will be presented to the University Council for consideration at its meeting on March 15, 1971.

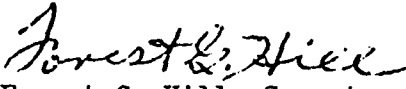
Forest G. Hill, Secretary
The University Council

RECOMMENDATION OF THE FACULTY SENATE

The Faculty Senate recommends that the Athletics Council be constituted as follows:

The Athletics Council shall be composed of five faculty members elected by the Faculty Senate of The University of Texas at Austin for terms of five years, with one member rotating off the Council each year; one ex-student elected by the Ex-Students' Association for a term of two years; three students elected by the elected student government for terms of two years; and the Athletic Director, who shall be the administrative adviser without vote. The Chairman of the Athletics Council shall be elected annually by the members of the Athletics Council from among their own number.

IMPLEMENTATION

Election of the Faculty Members: One faculty member shall be elected in 1971; one faculty member shall be elected in 1972 to fill the position now held by Professor Morgan; one faculty member shall be elected in 1973 to fill the position now held by Professor Cox; one faculty member shall be elected in 1974 to fill the position now held by Professor Macdonald; one faculty member shall be elected in 1975 to fill the position now held by Professor Thompson; and thereafter, one faculty member shall be elected annually--each for a term of five years.

Election of the Student Members: Two students shall be elected in 1971 for terms of two years; one student shall be elected initially for one year in 1971 and thereafter for a term of two years.

Election of the Ex-Student Member: The ex-student shall continue in office until 1972, at which time an election shall be held to fill the position for a term of two years.

Filed with the Secretary of the University Council by Mr. Charles Alan Wright, Chairman of the Faculty Senate, on March 9, 1971.

Distributed among the members of the University Council on March 12, 1971.

4. U. T. Austin: Establishment of the Piner Scholarship Fund in Architecture. --

Chancellor LeMaistre concurs in the recommendations of President Spurr and Associate Deputy Chancellor Shelton that the Piner Scholarship Fund in Architecture be established by the Board of Regents at U.T. Austin in memory of Mrs. Alma Jacobs House Piner and that the scholarship be awarded for the first time in September 1972.

2nd Mrs. Piner graduated from the University in 1917, the ~~third~~ woman to graduate in architecture. In accordance with the terms of her will, her estate was given to the University in 1949 with no restrictions on the manner of its use. The market value of the balance of the Piner Fund was approximately \$10,000 as of February 28, 1971.

The Piner Scholarship Fund in Architecture, to consist of income from the Piner Fund, will be restricted to students majoring in architecture and will be administered by the Office of Student Financial Aids in accordance with the policies set forth by the Committee on Financial Aid to Students.

August 12, 1971

Charles A. LeMaistre, M.D.
Chancellor
The University of Texas System

Dear Dr. LeMaistre:

After a review by this office of the suggestions from the Office of Investments, Trusts and Lands (see attached letter), I recommend the establishment of the Piner Scholarship Fund. Mrs. Piner was the third woman to graduate, 1917, in architecture at the University and, accordingly, it would be appropriate to restrict the awards to students majoring in architecture.

It is my further recommendation that the Office of Student Financial Aids be charged with the responsibility for its administration under the policies set forth by the Committee on Financial Aid to Students, and that this be placed on the September Agenda, if possible.

Sincerely,

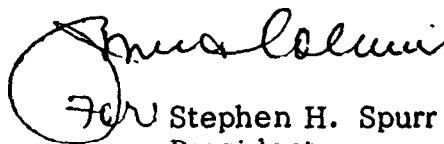
for Stephen H. Spurr
President

SHS:se

Encl.



512/471-5781

THE UNIVERSITY OF TEXAS SYSTEM

Office of Investments, Trusts and Lands

210 WEST SIXTH, AUSTIN, TEXAS 78701

PRESIDENT'S OFFICE
U.T. AUSTIN

REC'D APR 29 1971

REFER TO _____
HANDLE _____ READ & RETURN _____

April 28, 1971

President ad interim Bryce Jordan
The University of Texas at Austin
Main Building 102

Re: Alma Jacobs House Piner Fund

Dear Dr. Jordan:

We thought it in order to call to your attention the situation as to the Piner Fund which consists of \$8,667.98 book value and \$10,256 market value as of February 28, 1971, in our Common Trust Fund and a mineral interest in Yoakum County of doubtful value and carried on the accounting records at \$1.00. Income is now running at about \$430 annually.

Mrs. Piner's Will, admitted to probate after contest by relatives, reads as follows:

"6-18-1949

Board of Regents
University of Texas

Gentlemen:

I will all my estate, both personal and real, to the University of Texas to be used in any way that will help to further the growth, development, and progress of the University.

/s/ Alma Jacobs House Piner"

The Board of Regents in 1953 appropriated \$30,000 of funds from the Estate to the Piner Publication Fund for the University Press and later appropriated less than \$1,000 for some miscellaneous purposes. In 1959, a tract of land turned over to the University was sold, and the net proceeds of a little over \$5,000 placed in the Common Trust Fund with income to be re-invested until some recommendation for use of the income or principal.

Mrs. Piner was the third woman to graduate, 1917, in architecture at the University. You might want to consider a scholarship in architecture in her memory. If so, I would suggest that income be re-invested through August 31, 1971, and then accumulated with the first scholarship money to be available in September, 1972.

If you decide to make a recommendation to the Board of Regents, perhaps it should go through the Academic and Developmental Affairs Committee.

Sincerely,

Floyd O. Shelton
Associate Deputy Chancellor
for Investments, Trusts and Lands

md

**Buildings &
Grounds Com.**

BUILDINGS AND GROUNDS COMMITTEE

Date: September 8, 1971

Time: Following the meeting of the Academic and
Developmental Affairs Committee

Place: Main Building, Room 212
The University of Texas at Austin
Austin, Texas

Page
B & G

U. T. AUSTIN

1. Acceptance of Debt Service Grant CH-TEX-283(D)
for Married Student Apartments, Phase II 3
2. Authorization to Proceed with Working Drawings
and Specifications for Phase II, Married Student Housing
Units on the Old Confederate Home Site and Additional
Appropriation for Architect's Fees 3
3. Authorization for Two Landscape Improvements
on Twenty-sixth Street and San Jacinto Boulevard and
Appropriation Therefor 3
4. Additional Appropriation for Expansion of
Memorial Stadium and Building 4
5. Approval of Addition to Contract for Engineering
Teaching Center No. 1 and Appropriation Therefor 4
6. Approval of Preliminary Plans and Outline
Specifications and Authorization for Preparation of Final
Plans and Specifications for Construction of a Utility
Tunnel Paralleling Red River Street to Proposed Nursing
School and An Additional Appropriation Therefor 4

U. T. EL PASO

7. Additional Appropriation for Services and
Equipment for Education Building 5
8. Authorization for Repairs to Swimming Pool and
Appropriation Therefor 5

DALLAS MEDICAL SCHOOL

9. Approval of Preliminary Plans and Outline
Specifications for the Clinical Sciences Building (Including
Animal Facilities) and Additional Appropriation for
Architect's Fees 5
10. Notification of Reductions in Grant No.
1C05-PE-04056-01 for Florence Bioinformation Center and
Grant No. 1C05-CF-04053-01 for Basic Science Teaching
Unit and Appropriation Thereof 5

11. Authorization to Prepare Plans and Specifications for Redesign of the Air Conditioning System in the Hoblitzelle Building and Additional Appropriation Therefor 6

U. T. SAN ANTONIO

12. Authorization for the Installation of a 16-Inch Water Service Line and Appropriation Therefor 7

13. Appointment of Committee to Approve Metes and Bounds of Additional Right-of-Way Along Proposed Loop Road 1604 7

14. Approval of Final Plans and Specifications and Authorization to Advertise for Bids-Division I of Phase I for Site Work and Utilities Development 7

U. T. PERMIAN BASIN

15. Appointment of a Committee to Make a Study and Recommendation with Respect to Student Housing 8

16. Appointment of Architects for Preparation of Preliminary Plans for the Library-Administration Building and Appropriation Therefor 8

GALVESTON MEDICAL BRANCH

17. Approval of Final Plans and Specifications for Phase III of Extension of Chilled Water and Steam and Replacement of Sanitary Sewer Line and Appointment of a Committee to Award a Contract Therefor 8

1. U. T. AUSTIN - ACCEPTANCE OF DEBT SERVICE GRANT CH-TEX-283(D) FOR MARRIED STUDENT APARTMENTS, PHASE II.--Notice has been received from the Department of Housing and Urban Development that Debt Service Grant No. CH-TEX-283(D) for Phase II Married Student Housing Units at The University of Texas at Austin (Old Confederate Home site) has been approved. This grant is for an annual amount of \$91,832.00 for a period of thirty-five years, or a total of \$3,214,120.00. The grant will be paid annually over the life of the Housing Revenue Bonds to be issued and is for the purpose of paying the excess of interest over and above a 3% interest rate on these bonds. It is recommended by President Spurr and System Administration that the Board accept this grant as outlined above.

2. U. T. AUSTIN - AUTHORIZATION TO PROCEED WITH WORKING DRAWINGS AND SPECIFICATIONS FOR PHASE II, MARRIED STUDENT HOUSING UNITS ON THE OLD CONFEDERATE HOME SITE AND ADDITIONAL APPROPRIATION FOR ARCHITECT'S FEES.--At the Board of Regents' Meeting held October 23, 1970, the preliminary plans and outline specifications for Phase II, Married Student Housing Units at The University of Texas at Austin to be constructed on the "Old Confederate Home" site, were approved; however, authorization to proceed with working drawings and specifications was not requested pending notice concerning application for an interest subsidy grant from Housing and Urban Development. Notification has been received recently that this interest subsidy grant has been approved. Full information concerning this grant and the request for its acceptance is being presented at this Board meeting. It is recommended by President Spurr and System Administration that the Architects be authorized to proceed with the preparation of final plans and specifications to be presented to the Board for approval at a later date. It is further recommended that an additional appropriation of \$105,000.00 be made from Housing and Food Service of U. T. Austin to cover miscellaneous expenses and Architect's Fees for the preparation of final plans and specifications. This project is for 200 additional units having an area of approximately 153,000 gross square feet at an estimated total project cost of \$3,012,800.00.

3. U. T. AUSTIN - AUTHORIZATION FOR TWO LANDSCAPE IMPROVEMENTS ON TWENTY-SIXTH STREET AND SAN JACINTO BOULEVARD AND APPROPRIATION THEREFOR.--In the widening and improvement of Twenty-sixth Street, two areas requiring landscape treatments have been studied by the Office of Facilities Planning and Construction. Phase A extends along the north side of Twenty-sixth Street from the corner of University Avenue to the corner of Wichita Street and includes re-grading, drywall rock work and limited planting material at a total estimated cost of \$7,000.00. Phase B involves a triangular area approximately 200 feet by 400 feet by 360 feet located on the east side of the intersection of Twenty-sixth Street and San Jacinto Boulevard. The total estimated cost of Phase B is \$26,000.00 and includes removal of construction debris, new site work and curbing, irrigation system, grass sodding and tree planting.

It is, therefore, recommended by President Spurr and System Administration that authorization be given to the Office of Facilities Planning and Construction for the preparation of final plans and specifications and award of these landscaping improvements within the total estimated cost of \$33,000.00. It is further recommended that an appropriation of \$33,000.00 be made from Permanent University Fund Bond proceeds to cover the cost of this project.

4. U. T. AUSTIN - ADDITIONAL APPROPRIATION FOR EXPANSION OF MEMORIAL STADIUM AND BUILDING.--In accordance with authorization given at the October 31, 1969, Board of Regents' meeting, a construction contract was awarded to Lyda, Inc. and H. A. Lott, Inc. for \$12,824,000.00. Due to changes in scope of mechanical and electrical work since the bid opening date, an additional appropriation in the amount of \$160,000.00 from Permanent University Fund Bond proceeds is requested to increase the contract price above.

5. U. T. AUSTIN - APPROVAL OF ADDITION TO CONTRACT FOR ENGINEERING TEACHING CENTER NO. 1 AND APPROPRIATION THEREFOR.--The final plans and specifications for Engineering Teaching Center No. 1 and the results of widening and improving Twenty-Sixth Street have necessitated some major revisions to landscape and site development improvements. These modifications include retaining walls, drainage system, pedestrian access, and a minor revision of the planned utility extensions in the interface of the sites between the Physics-Mathematics-Astronomy Building and Engineering Teaching Center No. 1 and adjacent areas.

In order to accomplish these changes, it is recommended by President Spurr and System Administration that an additional appropriation of \$97,900.00 be made from Permanent University Fund Bond proceeds to this project to cover these modifications, Architect's Fees, and miscellaneous expenses therefor. Due to the favorable bids received on Engineering Teaching Center No. 1, all of the original two million dollar allocation from Permanent University Fund Bond proceeds was not required for the contract award.

6. U. T. AUSTIN - APPROVAL OF PRELIMINARY PLANS AND OUTLINE SPECIFICATIONS AND AUTHORIZATION FOR PREPARATION OF FINAL PLANS AND SPECIFICATIONS FOR THE CONSTRUCTION OF A UTILITY TUNNEL PARALLELING RED RIVER STREET TO PROPOSED NURSING SCHOOL AND AN ADDITIONAL APPROPRIATION THEREFOR.--In accordance with authorization given at the April 23, 1971 Regents' Meeting, B. Segall, Engineer, has prepared a study including preliminary plans and a cost estimate for the construction of a utility tunnel and electrical duct work from the north side of Nineteenth Street on Red River Street to the proposed School of Nursing. The proposed work includes a piping system within the tunnel plus direct buried piping across the University Junior High site to the existing tunnel terminating on the east side of San Jacinto Street at Nineteenth. Because of the economies to be gained, the proposed system of utility piping and the electrical duct system will be sized to serve all of The University of Texas facilities presently constructed and to be constructed south of Nineteenth Street and will include the necessary conversions within the Collections Deposit Library and Little Campus boiler rooms. The estimated cost of this project, including Engineer's Fees and administrative costs, is \$1,015,520.00. Once these proposed utilities have been installed south of Nineteenth Street, only short connecting links will be required to serve future projects, and the cost of these individual connections will be included in each project budget.

The preliminary plans have been reviewed and approved by the Office of Facilities Planning and Construction, and it is recommended by President Spurr and System Administration that they be approved by the Board and that B. Segall, Engineer, be authorized to proceed with preparation of working drawings and specifications for bid documents to be presented to the Board at a later date for approval.

It is further recommended that an additional appropriation from Permanent University Fund Bond proceeds be approved to cover miscellaneous expenses and Engineer's Fees through preparation of final plans and specifications in the amount of \$45,000.00, \$5,000.00 having been previously appropriated.

7. U. T. EL PASO - ADDITIONAL APPROPRIATION FOR SERVICES AND EQUIPMENT FOR EDUCATION BUILDING.--At the time the specifications were prepared for the Education Building at The University of Texas at El Paso, several areas were left uncompleted because of lack of funds, and at the time the building was occupied, some of the desired specialized equipment was not provided for this same reason. In order to make the entire building functional, additional wiring for certain areas and additional equipment and additional classroom seating is required. It is recommended by President Smiley, Vice-President Pennington, and System Administration that a total of \$50,000.00 from U. T. El Paso Unexpended Plant Funds - Building Revenue Bonds, Series 1969 - Unappropriated Balance be appropriated for these purposes.

8. U. T. EL PASO - AUTHORIZATION FOR REPAIRS TO SWIMMING POOL AND APPROPRIATION THEREFOR.--In order to provide year around use of the swimming pool for recreational and educational purposes, an enclosure is necessary. It is recommended by Vice-President Pennington, President Smiley, and System Administration that an appropriation of \$53,000.00 be made from Permanent University Fund Bond proceeds which have been allocated for this project to cover the cost of the installation.

9. DALLAS MEDICAL SCHOOL - APPROVAL OF PRELIMINARY PLANS AND OUTLINE SPECIFICATIONS FOR THE CLINICAL SCIENCES BUILDING (INCLUDING ANIMAL FACILITIES) AND ADDITIONAL APPROPRIATION FOR ARCHITECT'S FEES.--In accordance with authorization given by the Board at the meetings held July 10, 1970, September 12, 1970, and July 30, 1971, preliminary plans and outline specifications have been prepared by the associated architectural firms of Fisher and Spillman, Architects, Inc., Dallas, Texas, and Preston M. Geren, Fort Worth, Texas. These preliminary plans and specifications have been approved by Dean Sprague and System Administration, and it is recommended that they be approved by the Board with authorization to the architects to prepare working drawings and specifications to be presented to the Board for approval at a later meeting. These plans and specifications will cover a building of approximately 268,000 gross square feet at an estimated total project cost of \$17,050,000.00.

Dusa

It is further recommended that an additional appropriation of \$550,000.00 (\$120,000.00 has been previously appropriated) be approved from Permanent University Fund Bond proceeds to cover miscellaneous expenses and architect's fees for the preparation of final plans and specifications.

10. DALLAS MEDICAL SCHOOL - NOTIFICATION OF REDUCTIONS IN GRANT NO. 1C05-CF-04056-01 FOR FLORENCE BIOINFORMATION CENTER AND GRANT NO. 1C05-CF-04053-01 FOR BASIC SCIENCE TEACHING UNIT AND APPROPRIATION THEREOF.--In accordance with authorization given by the Board at the July 10, 1970 and October 23, 1970 meetings, Public Health Service grants were accepted for four buildings of Phase I program for the Dallas Medical School - Basic Science Teaching Building (Teaching Unit and Four Lecture Rooms), Fred F. Florence Memorial Library and Biomedical Information Center, Auditorium and Cafeteria and Academic and Administration Building. Successive authorizations by the Board followed and in the April 23, 1971 meeting the Board approved award of the construction contract based on the favorable bids received on April 20, 1971. The construction contractor's bid for two buildings - Basic Science Teaching Unit (Teaching Unit and Four Lecture Rooms) and Fred F. Florence Memorial Library and Biomedical Information Center - underran the estimated project construction cost upon which these grants were made and accepted. On May 3, 1971, a visit was made to the National Institutes of Health to request transfer of these funds to the other two facilities and to request additional equipment participation. This verbal request was confirmed in writing on May 26, 1971. The granting agency denied additional

participation in equipment by letter of June 10, 1971. Further, on July 22, 1971, the granting agency furnished formal notice of reduction in grants for the Basic Science Teaching Unit (Teaching Unit and Four Lecture Rooms) and the Fred F. Florence Memorial Library and Biomedical Information Center only. A recapitulation of the grants for these four facilities follows:

Facility

Basic Science Teaching Unit (Teaching Unit and Four Lecture Rooms) (PHS Grant No. 1C05-CF-04053-01 Rev.)	\$12,725,436	\$10,791,187
Fred F. Florence Memorial Library and Biomedical Information Center (PHS Grant No. 1C05-CF-04056-01 Rev.)	2,924,976	1,937,976
Academic and Administration Building (PHS Grant No. 1C05-CF-04055-01)	1,249,310	No change
Auditorium and Cafeteria (PHS Grant No. 1C05-CF-04054-01)	1,439,312	No change

It is recommended by Dean Sprague and System Administration that the Board accept the reductions as outlined above, and that the revised grant amounts be appropriated to the projects.

11. DALLAS MEDICAL SCHOOL - AUTHORIZATION TO PREPARE PLANS AND SPECIFICATIONS FOR REDESIGN OF THE AIR CONDITIONING SYSTEM IN THE HOBLITZELLE BUILDING AND ADDITIONAL APPROPRIATION THEREFOR.--At the October 31, 1969, Meeting of the Board of Regents, the firm of Gaynor and Sirmen, Inc., Engineers, was appointed to make an engineering study of the air conditioning deficiencies and prepare a report with respect to redesigning the air conditioning system. An appropriation of \$18,000.00 was approved for engineering services. The results of the analysis made by Gaynor and Sirmen, Inc., and concurred in by the Office of Facilities Planning and Construction is that the entire air conditioning system in the building calls for a major renovation and almost complete replacement of the system now in use.

The building was constructed in 1955 and has been in use for some 16 years. It is not unreasonable to expect the life of the system to be 20 years before renovation. The building is now being used with different equipment in the laboratories than was originally contemplated for the use of the building, therefore, the original design capacity is not sufficient to provide for present use and reasonable anticipated increase in load. The duct system will have to be enlarged and the individual air handling units will have to be replaced.

An estimated cost of the total project is \$1,130,000.00, but it is contemplated that the renovation and replacement will be performed in stages. Part of this cost includes a plan to insure that the building remain fully occupied and that research be conducted without disruption.

It is recommended by Dean Sprague and System Administration that Gaynor and Sirmen, Inc., be authorized to prepare the plans and specifications for the redesign, renovation, and replacement of the present air conditioning system in the Hoblitzelle Building for a fee not to exceed \$45,000.00. It is necessary to have the plans and specifications for the complete project in order to determine the appropriate construction stages to insure an overall efficient system. It is further recommended that an appropriation of \$45,000.00 be made from Permanent University Fund Bond proceeds for miscellaneous expenses and engineering fees for this project.

12. U.T. SAN ANTONIO - AUTHORIZATION FOR THE INSTALLATION OF A 16-INCH WATER SERVICE LINE TO THE UNIVERSITY OF TEXAS AT SAN ANTONIO AND APPROPRIATION THEREFOR.--In order to provide the water requirements for The University of Texas at San Antonio, it is necessary to install a meter vault for a 10" x 12" Detector Meter, and also a pro rata charge for a 16-inch water service line to connect to the distribution mains provided by the City Water Board of San Antonio. The amount due the City Water Board is \$25,844.69 for this service.

It is recommended by President Templeton and System Administration that the Director of the Office of Facilities Planning and Construction be authorized to execute an agreement with the City Water Board for this service. It is further recommended that an appropriation of \$25,844.69 be made from Permanent University Fund Bond Proceeds as an advance to be repaid from Tuition Revenue Bond Proceeds at a later date.

13. U. T. SAN ANTONIO - APPOINTMENT OF COMMITTEE TO APPROVE METES AND BOUNDS OF ADDITIONAL RIGHT-OF-WAY ALONG PROPOSED LOOP ROAD 1604.-- A request has been received from the Texas Highway Department that the University transfer to the Department additional acreage along the north boundary of The University of Texas at San Antonio campus site to facilitate the design of needed access roads and to coordinate the highway design with the overall site plans as developed by the Associated Architects and approved by the Board June 4, 1971. The studies indicating the exact metes and bounds of the estimated seven acres required have not been completed by the Highway Department. In order to advertise for bids for the Division I of site work and utilities development, which is recommended for approval elsewhere in this Agenda, authorization for the approval of the exact acreage and final metes and bounds is needed as soon as the field notes have been prepared by the Highway Department. It is, therefore, recommended that the exact metes and bounds and total acreage be approved by a Committee consisting of President Templeton, Mr. R. S. Kristoferson, Deputy Chancellor Walker, and Chairman Peace. It is further recommended that Chairman Peace be authorized to execute any and all documents necessary to effect the transfer of property to the State Highway Department for right-of-way purposes.

14. U. T. SAN ANTONIO - APPROVAL OF FINAL PLANS AND SPECIFICATIONS AND AUTHORIZATION TO ADVERTISE FOR BIDS-DIVISION I OF PHASE I FOR SITE WORK AND UTILITIES DEVELOPMENT.--At the meeting of the Board held June 4, 1971, the preliminary plans and outline specifications for the buildings, site development, and utility distribution for the Phase I development of The University of Texas at San Antonio were approved. Authorization was given for the preparation of working drawings and specifications to be presented to the Board at a later meeting.

It has been determined that phasing of the site preparation and utility development will expedite the building construction schedule and that Division I, or the initial phase, of site work can be substantially completed prior to the bidding of the building construction project. The scope of this work consists of access roads to construction sites, blasting for all necessary excavation, clearing entire construction site, tunnels, and below grade utility distribution to connection points for buildings.

Plans and specifications covering Division I of the Phase I site development and utilities distribution have been prepared by the firms of Ford, Powell and Carson, San Antonio, Texas, and Bartlett Cocke and Associates, San Antonio, Texas, Associated Architects. The estimated construction cost of \$1,425,000.00 is included in the overall estimated cost of the Phase I building program at The University of Texas at San Antonio. The plans and specifications have been approved by President Templeton and System Administration, and it is recommended that they be approved by the Board with authorization to the Director of the Office of Facilities Planning and Construction to advertise for bids to be presented to the Board or the Executive Committee at a later date.

15. U. T. PERMIAN BASIN - APPOINTMENT OF A COMMITTEE TO MAKE A STUDY AND RECOMMENDATION WITH RESPECT TO STUDENT HOUSING.--Certain private parties have indicated an interest in constructing student housing on The University of Texas of the Permian Basin campus. House Bill 1528 passed by the 62nd Legislature authorizes the Board of Regents of The University of Texas System to enter into contracts with any entities, public or private, for the lease of land for the purpose of construction of utilities plants, student housing, and student and staff services facilities.

System Administration concurs with the recommendation of President Amstead that a committee of Regent Erwin, Deputy Chancellor Walker, and President B. H. Amstead be appointed to review and recommend to a future meeting of the Board of Regents the action that should be considered by the Board with regard to allowing private parties to construct student housing on The University of Texas land. This committee should be authorized to discuss with prospective builders such matters as may be pertinent to the committee recommendation to the Board.

16. U. T. PERMIAN BASIN - APPOINTMENT OF ARCHITECTS FOR PREPARATION OF PRELIMINARY PLANS FOR THE LIBRARY-ADMINISTRATION BUILDING AND APPROPRIATION THEREFOR.--President Amstead recommends that the firm of Jessen, Associates, Inc., associated with Peters and Fields of Odessa, Texas, be authorized to prepare preliminary plans for the Library-Administration Building (Phase II of U. T. Permian Basin development plans). This building has not been previously authorized by the Board of Regents, but has been a part of the overall development plan for The University of Texas of the Permian Basin. The estimated construction cost of this building is \$7,800,000 and will include approximately 234,400 square feet of enclosed space.

System Administration recommends that the Board authorize the firm of Jessen Associates, Inc., associated with Peters and Fields of Odessa, Texas to proceed with the preparation of preliminary plans for the Library-Administration Building and approve an advance from Permanent University Fund Bond Proceeds of \$66,000 to cover the cost of preparation of preliminary plans. The advance from Permanent University Fund Bond Proceeds is to be repaid from the proceeds of tuition revenue bonds when issued and allocated to The University of Texas of the Permian Basin.

17. GALVESTON MEDICAL BRANCH - APPROVAL OF FINAL PLANS AND SPECIFICATIONS FOR PHASE III OF EXTENSION OF CHILLED WATER AND STEAM AND REPLACEMENT OF SANITARY SEWER LINE AND APPOINTMENT OF A COMMITTEE TO AWARD CONTRACT THEREFOR.--In accordance with authorization given by the Board at the meeting held June 4, 1971, final plans and specifications for Phase III of Extension of Chilled Water and Steam and Replacement of Sanitary Sewer Line at The University of Texas Medical Branch at Galveston have been prepared by Ray S. Burns and Associates, Engineer for the project, and approved by President Blocker and System Administration. It is recommended that they be approved by the Board and authorization be given to the Director of Facilities Planning and Construction to advertise for bids. Due to the critical need for the replacement of the sanitary sewer line, it is recommended that a Committee, consisting of President Blocker, Mr. R. S. Kristoferson, Deputy Chancellor Walker, and Chairman Peace, be appointed to award a contract to the lowest acceptable bidder within the authorized project budget of \$480,000.00.

*Use in Writing
minutes.
BAF* *cal*

EMERGENCY ITEMS
BUILDINGS AND GROUNDS COMMITTEE

Date: September 8, 1971

Time: Following the meeting of the Academic and
Developmental Affairs Committee

Place: Main Building, Room 212
The University of Texas at Austin
Austin, Texas

Page
B & G

SYSTEM NURSING SCHOOL AND U. T. AUSTIN NURSING SCHOOL

18. Award of Contract to J. C. Evans Construction
Company, Inc., for New Building and Appropriation Therefor 10

U. T. AUSTIN

19. Award of Contracts to Lato Sales Company and
Kewaunee Scientific Equipment Company for Non-Fixed Labora-
tory Equipment for Physics-Mathematics-Astronomy Building 10

20. Award of Contracts to Abel Contract Furniture
and Equipment Company, Inc., Estey Corporation, Rockford
Furniture Associates, and Dallas Office Supply Company for
Furniture and Furnishings for Humanities Research Center 11

U. T. ARLINGTON

21. Award of Contract to Osborne-Lee Construction
Company for Swift School Renovation 12

13

DALLAS MEDICAL SCHOOL

22. Rejection of Bids for Piping Connections to Central
Utility Plant 13

GALVESTON MEDICAL BRANCH

23. Award of Contracts to Dallas Office Supply Company,
Stewart Office Supply Company, and Library Bureau, Division
of Remington Rand-Sperry Rand Corporation for Furniture and
Furnishings for Moody Medical Library 14

18. SYSTEM NURSING SCHOOL AND U. T. AUSTIN NURSING SCHOOL - AWARD OF CONTRACT TO J. C. EVANS CONSTRUCTION COMPANY, INC., FOR NEW BUILDING AND APPROPRIATION THEREFOR.--In accordance with authorization given by the Board at the Meeting held April 23, 1971, bids on the new building for The University of Texas Nursing School (System-wide) at Austin and The University of Texas (Undergraduate) Nursing School at Austin were called for and were received, opened and tabulated on August 19, 1971, as shown on the attached tabulation sheet. (Page 15)

It is recommended by Dean Willman and System Administration that subject to concurrence of the Federal granting agency a contract award be made to the low bidder, J. C. Evans Construction Company, Inc., Austin, Texas, as follows:

Base Bid	\$2,714,860.00
Add Alternates:	
No. 1 (Complete Mezzanine Lounges)	45,233.00
No. 2 (Add Elevator No. 3)	18,500.00
No. 3 (Add Elevator No. 4)	18,500.00
No. 4 (Add Venetian Blinds)	15,500.00
No. 7 (Add Carpeting)	<u>4,500.00</u>
Total Recommended Contract Award	<u>\$2,817,093.00</u>

In order to cover this recommended contract award, Architect's Fees thereon, movable furniture and equipment, and miscellaneous expenses, it is recommended that a total appropriation of ~~\$3,183,460.00~~ be approved for this project, ~~\$1,278,124.00~~ to come from Federal grant No. 1C05-NI-04065-01 already reported and accepted by the Board, and ~~\$1,905,336.00~~ to come from Permanent University Fund Bond proceeds. Of this amount to come from Permanent University Fund Bond proceeds, ~~\$104,000.00~~ has already been appropriated to cover part of the Architect's fees and miscellaneous expenses.

This building covers approximately 99,815 gross square feet.

19. U. T. AUSTIN - AWARD OF CONTRACTS TO LATO SALES COMPANY AND KEWAUNEE SCIENTIFIC EQUIPMENT COMPANY FOR NON-FIXED LABORATORY EQUIPMENT FOR PHYSICS-MATHEMATICS-ASTRONOMY BUILDING.--Specifications for Non-Fixed Laboratory Equipment for the Physics-Mathematics-Astronomy Building at The University of Texas at Austin were prepared in the Office of Facilities Planning and Construction, and bids were called for, received, opened and tabulated on August 25, 1971, as shown below:

	Central Distributing Company, San Antonio, Texas	Lato Sales Company, Dallas, Texas	Kewaunee Scientific Equipment Corporation, Adrian, Michigan
Base Bid A	\$27,936.23	\$26,451.70	\$ 28,843.00
Alt. No. 1 to Base Bid A - Deduct	2,598.03	2,200.00	2,465.00
Alt. No. 2 to Base Bid A - Deduct	7,149.42	6,468.00	6,826.00
Base Bid B	No Bid	No Bid	215,990.00
Alt. No. 1 to Base Bid B - Deduct	No Bid	No Bid	39,560.00
Alt. No. 2 to Base Bid B - Deduct	No Bid	No Bid	80,781.00
Bidder's Bond	1,500.00	5%	13,200.00

It is recommended by President Spurr and System Administration that contract awards be made to the low bidder, as follows:

Krista's Comments
3 no bid for kil dal

Base Proposal A - Workbenches		
Lato Sales Company, Dallas, Texas	\$ 26,451.70	
Alternate No. 1 (Delete 8 Workbenches) Deduct	<u>2,200.00</u>	\$ 24,251.70
Base Proposal B - Laboratory Casework		
Kewaunee Scientific Equipment Corporation, Adrian, Michigan	\$215,990.00	
Alternate No. 1 (Delete certain equipment) Deduct	<u>39,560.00</u>	<u>\$176,430.00</u>
Total Recommended Contract Awards		<u>\$200,681.70</u>

Although only one bid was received on the Laboratory Casework, it is considered a good bid in line with estimates made and it is not believed that another call would produce better bids, since bid inquiries were sent to eight qualified to meet our specifications. It is desirable to award a contract at this time to Kewaunee to insure the completion of this project. The funds for these recommended contract awards are available in the Allotment Account for the project, which included a total estimated cost of \$239,150.00 for these awards.

20. U. T. AUSTIN - AWARD OF CONTRACTS TO ABEL CONTRACT FURNITURE AND EQUIPMENT COMPANY, INC., ESTEY CORPORATION, ROCKFORD FURNITURE ASSOCIATES, AND DALLAS OFFICE SUPPLY COMPANY FOR FURNITURE AND FURNISHINGS FOR HUMANITIES RESEARCH CENTER.--In accordance with authorization given by the Board at the meeting held July 30, 1971, bids for Furniture and Furnishings for the Humanities Research Center at The University of Texas at Austin have been called for and were received, opened, and tabulated on August 25, 1971, as shown on attached tabulation sheet. (Page 16) It is recommended by President Spurr and System Administration that contract awards be made to the low bidders, as follows:

Base Proposal A - General Office, Lounge and Lecture Room Furniture Abel Contract Furniture and Equipment Company, Inc., Austin, Texas		\$135,685.54
Base Proposal B - Library Technical Furniture Abel Contract Furniture and Equipment Company, Inc., Austin, Texas		37,811.56
Base Proposal C - Steel Bookstacks Estey Corporation, Red Bank, New Jersey		7,041.00
Base Proposal D - Display Panels Rockford Furniture Associates, Austin, Texas		20,860.00
Base Proposal E - Draperies Rockford Furniture Associates, Austin, Texas		3,530.00
Base Proposal F - Storage Rods, Racks, etc. Dallas Office Supply Company, Dallas, Texas		<u>4,968.39</u>
Total Recommended Contract Awards		<u>\$209,896.49</u>

The total of these recommended contract awards is within the estimated amount of \$300,000.00 for the furniture and furnishings, and the funds are available in the Allotment Account for the project.

21. U. T. ARLINGTON - AWARD OF CONTRACT TO OSBORNE-LEE CONSTRUCTION COMPANY FOR SWIFT SCHOOL RENOVATION.--In accordance with authorization given by the Board at the meeting held July 30, 1971, bids were called for and were received, opened, and tabulated on September 2, 1971, for the Renovation of Swift School at The University of Texas at Arlington as shown below:

	Dowd Construction Co., Inc., Dallas, Texas	Kugler-Morris, General Contractors, Inc., Dallas, Texas	Osborne-Lee Construction Co., Arlington, Texas	Walker Construction Company, Fort Worth, Texas
Base Bid	\$448,000.00	\$422,000.00	\$392,588.00	\$415,000.00
Alternates:				
No. 1				
Deduct	2,323.00	4,200.00	3,245.00	3,500.00
No. 2				
Deduct	2,619.00	3,100.00	1,046.00	2,000.00
No. 3				
Deduct	1,090.00	2,300.00	3,546.00	No Change
No. 4				
Deduct	2,419.00	2,700.00	2,620.00	3,000.00
No. 5				
Deduct	12,423.00	15,000.00	8,226.00	10,700.00
No. 6				
Deduct	11,976.00	12,000.00	10,997.00	11,500.00
No. 7				
Deduct	208.00	350.00	325.00	270.00
No. 8				
Deduct	915.00	600.00	1,259.00	1,600.00
No. 9				
Deduct	1,418.00	1,100.00	1,301.00	1,370.00
No. 10				
Deduct	1,300.00	1,300.00	1,300.00	1,450.00
No. 11				
Deduct	916.00	1,600.00	1,505.00	110.00
No. 12				
Deduct	-0-	150.00	No Change	No Change
No. 13				
Deduct	400.00	400.00	500.00	600.00
No. 14				
Deduct	21,000.00	11,000.00	42,950.00	30,000.00
No. 15				
Deduct	± 700.00	No Change	± 7,700.00	± 1,500.00
No. 16				
Add	5,300.00	5,800.00	5,210.00	5,500.00

Each bidder submitted with his bid a bidder's bond in the amount of 5% of the greatest amount bid

It is recommended by President Harrison, Vice-President Price, and System Administration that a contract award be made to the low bidder, Osborne-Lee Construction Company, Arlington, Texas, as follows:

Base Bid		\$392,588.00
Deductive Alternates:		
No. 3	\$ 3,546.00	
No. 6	10,997.00	
No. 9	1,301.00	
No. 10	1,300.00	
No. 11	1,505.00	
No. 13	500.00	
No. 14	42,950.00	
No. 15	<u>7,700.00</u>	<u>69,799.00</u>
Total Recommended Contract Award		<u>\$322,789.00</u>

The total of this recommended contract award, Architect's Fees thereon, estimated amount of movable furniture and equipment, and miscellaneous expenses is within the appropriation of \$375,000.00 for this project, which involves remodeling of a building of approximately 31,248 gross square feet.

22. DALLAS MEDICAL SCHOOL - REJECTION OF BIDS FOR PIPING CONNECTIONS TO CENTRAL UTILITY PLANT.--In accordance with authorization given at the Regents' Meeting held July 30, 1971, bids were called for and were received, opened, and tabulated on September 2, 1971, for Piping Connections to Central Utility Plant for certain buildings on the Campus of The University of Texas Southwestern Medical School at Dallas.

The estimated cost of this project was \$90,000.00, and because of the extremely high bids received, it is recommended by Dean Sprague and System Administration that all bids be rejected and that bids be called for again after re-examination of the plans and specifications, these bids to be presented to the Board or the Executive Committee for consideration at a later date.

23. GALVESTON MEDICAL BRANCH - AWARD OF CONTRACTS TO DALLAS OFFICE SUPPLY COMPANY, STEWART OFFICE SUPPLY COMPANY, AND LIBRARY BUREAU, DIVISION OF REMINGTON RAND-SPERRY RAND CORPORATION FOR FURNITURE AND FURNISHINGS FOR MOODY MEDICAL LIBRARY.--Specifications for Furniture and Furnishings for the Moody Medical Library at The University of Texas Medical Branch at Galveston were prepared in the Office of Facilities Planning and Construction, and bids were called for, received, opened, and tabulated on August 25, 1971, as shown on the attached tabulation sheet. (Page 17)

It is recommended by President Blocker and System Administration that contract awards be made to the low bidders, as follows:

Base Proposal A - General Office and Lounge Furniture		
Dallas Office Supply Company, Dallas, Texas		
Base Proposal	\$123,205.33	
Less Alternate No. 1 (Delete Planters) Deduct	<u>8,601.92</u>	\$114,603.41
Base Proposal B - Library Furniture and Wood Shelving		
Stewart Office Supply Company, Dallas, Texas		27,290.34
Base Proposal C - Library Bookstacks		
Library Bureau, Division of Remington Rand - Sperry Rand Corporation, Houston, Texas		<u>63,550.00</u>
		62,500.00
Total Recommended Contract Awards		<u>\$205,443.75</u>

The bids of Estey Corporation and John Sjostrom and Company on Base Proposal B were not in accordance with the specifications and, therefore, could not be considered as valid bids, hence, the recommendation of award to Stewart Office Supply Company, the lowest bidder meeting specifications. The estimated cost for the furniture and furnishings for this project was \$205,000.00. However, because of other necessary expenditures out of the Allotment Account for this project, it is further recommended that an appropriation of \$5,000.00 be made to this project from Interest Earned on Private Gifts for the Moody Medical Library.

THE UNIVERSITY OF TEXAS NURSING SCHOOL SYSTEM-WIDE AT AUSTIN

Bids Received at the Office of Facilities Planning and Construction
The University of Texas System, Austin, Texas, at 2:00 P. M., August 19, 1971

Bidder	Base Bid	Alternates								Bidder's Bond
		No. 1 Add	No. 2 Add	No. 3 Add	No. 4 Add	No. 5	No. 6	No. 7 Add	No. 8 Add	
B-F-W Construction Company, Inc., Temple, Texas	\$2,935,900	\$50,000	\$19,800	\$19,800	\$14,500	-\$13,000	+\$13,500	\$4,000	\$9,000	5%
Cates Construction Company, Inc., Dallas, Texas	2,984,000	52,000	20,000	19,600	15,000	- 16,000	+ 24,000	5,000	9,000	5%
J. C. Evans Construction Company, Inc., Austin, Texas	2,714,860	45,233	18,500	18,500	15,500	+ 8,000	+ 12,000	4,500	8,835	5%
Everhard Construction Company, Austin, Texas	2,884,228	48,418	17,835	17,539	5,000	- 8,311	+ 10,811	3,525	9,835	5%
Lawless and Alford, Inc., Austin, Texas	3,092,613	46,175	18,000	18,000	14,000	No Bid	No Bid	3,591	9,500	5%
Stokes Construction Company, San Marcos, Texas	3,037,303	39,700	18,700	18,700	14,700	- 34,700	- 28,700	3,700	8,700	5%
Waco Construction, Inc., Waco, Texas	3,045,500	35,500	21,000	21,000	14,000	- 10,000	+ 25,000	4,500	8,400	5%
Warrior Constructors, Division Paramount Warrior, Inc., Houston, Texas	3,027,000	49,000	19,000	19,000	14,000	- 15,000	- 5,000	6,000	8,000	5%

FURNITURE AND FURNISHINGS FOR HUMANITIES RESEARCH CENTER
THE UNIVERSITY OF TEXAS AT AUSTIN

Bids Received at the Office of Facilities Planning and Construction
The University of Texas System, Austin, Texas, at 2:00 P. M., August 25, 1971

Bidder	Base Bid A	Base Bid B	Base Bid C	Base Bid D	Base Bid E	Base Bid F	Completion Time	Bidder's Bond
Abel Contract Furniture and Equipment Company, Inc., Austin, Texas	\$135,685.54	\$37,811.56	\$ No Bid	\$22,844.50	\$ No Bid	\$ No Bid	90 days	5%
Dallas Office Supply Company, Dallas, Texas	139,978.33	50,137.34	No Bid	36,783.00	4,136.50	4,968.39	150 days	5%
Estey Corporation, Red Bank, New Jersey	----	----	7,041.00	----	----	----	90 days	\$400.00
Rockford Furniture Associates, Austin, Texas	139,523.24	49,166.07	No Bid	20,860.00	3,530.00	8,652.50	75 days	5%
Scott-Rice Company, Irving, Texas	145,921.77	48,674.71	No Bid	No Bid	No Bid	No Bid	110 days	5%
Stewart Office Supply Company, Dallas, Texas	139,266.06	50,608.66	No Bid	No Bid	No Bid	No Bid	60 - 90 days 100 - 120 days on Thonet	5%

FURNITURE AND FURNISHINGS FOR MOODY MEDICAL LIBRARY
THE UNIVERSITY OF TEXAS MEDICAL BRANCH AT GALVESTON

Bids Received at the Office of Facilities Planning and Construction
The University of Texas System, Austin, Texas, at 2:00 P. M., August 25, 1971

Bidder	Base Bid A	Deduct Alt. 1 to Bid A	Base Bid B	Deduct Alt. 1 to Bid B	Base Bid C	Deduct Alt. 1 to Bid C	Deduct Alt. 2 to Bid C	Bidder's Bond	Completion Time
Abel Contract Furniture and Equip- ment Company, Inc., Austin, Texas	\$124,138.30	\$7,720.00	\$29,628.47	\$3,402.00	\$85,218.80	\$4,663.44	\$ 9,041.00	5%	90 days
Dallas Office Supply Company, Dallas, Texas	123,205.33	8,601.92	29,465.90	3,382.50	No Bid	No Bid	No Bid	5%	120 days
Estey Corporation, Red Bank, New Jersey	No Bid	No Bid	19,450.00	1,854.00	69,206.00	4,150.10	11,451.00	\$5,000	90 days
Inter Royal Corporation, New York, New York	No Bid	No Bid	No Bid	No Bid	74,165.00	8,500.00	8,700.00	4,500	60 days
Library Bureau, Division of Reming- ton Rand, Sperry Rand Corporation, Houston, Texas	No Bid	No Bid	---	No Bid	63,500.00	3,473.64	3,164.15	5%	90 days
Rockford Furniture Associates, Austin, Texas	123,389.17	8,589.20	27,730.38	2,803.20	79,108.23	4,558.24	4,752.30	5%	75 days
Scott-Rice Company, Irving, Texas	129,951.45	8,450.80	No Bid	No Bid	No Bid	No Bid	No Bid	5%	110 days
John E. Sjostrom Company, Inc., Philadelphia, Pennsylvania	No Bid	---	27,017.00	2,721.00	No Bid	---	---	5%	90-120 days
Stewart Office Supply Company, Dallas, Texas	126,433.76	8,722.56	27,290.34	2,807.19	No Bid	No Bid	No Bid	5%	(110 days - Thonet (60-90 days on bal.

Cal

EMERGENCY ITEMS
BUILDINGS AND GROUNDS COMMITTEE

Date: September 8, 1971

Time: Following the meeting of the Academic and
Developmental Affairs Committee

Place: Main Building, Room 212
The University of Texas at Austin
Austin, Texas

Page
B & G

SYSTEM NURSING SCHOOL AND U. T. AUSTIN NURSING SCHOOL

18. Award of Contract to J. C. Evans Construction
Company, Inc., for New Building and Appropriation Therefor 10

U. T. AUSTIN

19. Award of Contracts to Lato Sales Company and
Kewaunee Scientific Equipment Company for Non-Fixed Labora-
tory Equipment for Physics-Mathematics-Astronomy Building 10

20. Award of Contracts to Abel Contract Furniture
and Equipment Company, Inc., Estey Corporation, Rockford
Furniture Associates, and Dallas Office Supply Company for
Furniture and Furnishings for Humanities Research Center 11

U. T. ARLINGTON

21. Award of Contract to Osborne-Lee Construction
Company for Swift School Renovation 12

13

DALLAS MEDICAL SCHOOL

22. Rejection of Bids for Piping Connections to Central
Utility Plant 13

GALVESTON MEDICAL BRANCH

23. Award of Contracts to Dallas Office Supply Company,
Stewart Office Supply Company, and Library Bureau, Division
of Remington Rand-Sperry Rand Corporation for Furniture and
Furnishings for Moody Medical Library 14

18. SYSTEM NURSING SCHOOL AND U. T. AUSTIN NURSING SCHOOL - AWARD OF CONTRACT TO J. C. EVANS CONSTRUCTION COMPANY, INC., FOR NEW BUILDING AND APPROPRIATION THEREFOR.--In accordance with authorization given by the Board at the Meeting held April 23, 1971, bids on the new building for The University of Texas Nursing School (System-wide) at Austin and The University of Texas (Undergraduate) Nursing School at Austin were called for and were received, opened and tabulated on August 19, 1971, as shown on the attached tabulation sheet. (Page 15)

It is recommended by Dean Willman and System Administration that subject to concurrence of the Federal granting agency a contract award be made to the low bidder, J. C. Evans Construction Company, Inc., Austin, Texas, as follows:

Base Bid	\$2,714,860.00
Add Alternates:	
No. 1 (Complete Mezzanine Lounges)	45,233.00
No. 2 (Add Elevator No. 3)	18,500.00
No. 3 (Add Elevator No. 4)	18,500.00
No. 4 (Add Venetian Blinds)	15,500.00
No. 7 (Add Carpeting)	<u>4,500.00</u>
Total Recommended Contract Award	<u>\$2,817,093.00</u>

In order to cover this recommended contract award, Architect's Fees thereon, movable furniture and equipment, and miscellaneous expenses, it is recommended that a total appropriation of \$3,183,460.00 be approved for this project, \$1,278,124.00 to come from Federal grant No. 1C05-NT-04065-01 already reported and accepted by the Board, and \$1,905,336.00 to come from Permanent University Fund Bond proceeds. Of this amount to come from Permanent University Fund Bond proceeds, \$104,000.00 has already been appropriated to cover part of the Architect's Fees and miscellaneous expenses.

This building covers approximately 99,815 gross square feet.

19. U. T. AUSTIN - AWARD OF CONTRACTS TO LATO SALES COMPANY AND KEWAUNEE SCIENTIFIC EQUIPMENT COMPANY FOR NON-FIXED LABORATORY EQUIPMENT FOR PHYSICS-MATHEMATICS-ASTRONOMY BUILDING.--Specifications for Non-Fixed Laboratory Equipment for the Physics-Mathematics-Astronomy Building at The University of Texas at Austin were prepared in the Office of Facilities Planning and Construction, and bids were called for, received, opened and tabulated on August 25, 1971, as shown below:

	Central Distribut- ing Company, San Antonio, Texas	Lato Sales Com- pany, Dallas, Texas	Kewaunee Scienti- fic Equipment Corporation, Adrian, Michigan
Base Bid A	\$27,936.23	\$26,451.70	\$ 28,843.00
Alt. No. 1 to Base Bid A - Deduct	2,598.03	2,200.00	2,465.00
Alt. No. 2 to Base Bid A - Deduct	7,149.42	6,468.00	6,826.00
Base Bid B	No Bid	No Bid	215,990.00
Alt. No. 1 to Base Bid B - Deduct	No Bid	No Bid	39,560.00
Alt. No. 2 to Base Bid B - Deduct	No Bid	No Bid	80,781.00
Bidder's Bond	1,500.00	5%	13,200.00

It is recommended by President Spurr and System Administration that contract awards be made to the low bidder, as follows:

Base Proposal A - Workbenches		
Lato Sales Company, Dallas, Texas	\$ 26,451.70	
Alternate No. 1 (Delete 8 Workbenches) Deduct	<u>2,200.00</u>	\$ 24,251.70
Base Proposal B - Laboratory Casework		
Kewaunee Scientific Equipment Corporation, Adrian, Michigan	\$215,990.00	
Alternate No. 1 (Delete certain equipment) Deduct	<u>39,560.00</u>	<u>\$176,430.00</u>
Total Recommended Contract Awards		<u>\$200,681.70</u>

Although only one bid was received on the Laboratory Casework, it is considered a good bid in line with estimates made and it is not believed that another call would produce better bids, since bid inquiries were sent to eight qualified to meet our specifications. It is desirable to award a contract at this time to Kewaunee to insure the completion of this project. The funds for these recommended contract awards are available in the Allotment Account for the project, which included a total estimated cost of \$239,150.00 for these awards.

20. U. T. AUSTIN - AWARD OF CONTRACTS TO ABEL CONTRACT FURNITURE AND EQUIPMENT COMPANY, INC., ESTEY CORPORATION, ROCKFORD FURNITURE ASSOCIATES, AND DALLAS OFFICE SUPPLY COMPANY FOR FURNITURE AND FURNISHINGS FOR HUMANITIES RESEARCH CENTER.--In accordance with authorization given by the Board at the meeting held July 30, 1971, bids for Furniture and Furnishings for the Humanities Research Center at The University of Texas at Austin have been called for and were received, opened, and tabulated on August 25, 1971, as shown on attached tabulation sheet. (Page 16) It is recommended by President Spurr and System Administration that contract awards be made to the low bidders, as follows:

Base Proposal A - General Office, Lounge and Lecture Room Furniture		
Abel Contract Furniture and Equipment Company, Inc., Austin, Texas	\$135,685.54	
Base Proposal B - Library Technical Furniture		
Abel Contract Furniture and Equipment Company, Inc., Austin, Texas	37,811.56	
Base Proposal C - Steel Bookstacks		
Estey Corporation, Red Bank, New Jersey	7,041.00	
Base Proposal D - Display Panels		
Rockford Furniture Associates, Austin, Texas	20,860.00	
Base Proposal E - Draperies		
Rockford Furniture Associates, Austin, Texas	3,530.00	
Base Proposal F - Storage Rods, Racks, etc.		
Dallas Office Supply Company, Dallas, Texas	<u>4,968.39</u>	
Total Recommended Contract Awards		<u>\$209,896.49</u>

The total of these recommended contract awards is within the estimated amount of \$300,000.00 for the furniture and furnishings, and the funds are available in the Allotment Account for the project.

21. U. T. ARLINGTON - AWARD OF CONTRACT TO OSBORNE-LEE CONSTRUCTION COMPANY FOR SWIFT SCHOOL RENOVATION.-- In accordance with authorization given by the Board at the meeting held July 30, 1971, bids were called for and were received, opened, and tabulated on September 2, 1971, for the Renovation of Swift School at The University of Texas at Arlington as shown below:

	Dowd Construction Co., Inc., Dallas, Texas	Kugler-Morris, General Contractors, Inc., Dallas, Texas	Osborne-Lee Construction Co., Arlington, Texas	Walker Construction Company, Fort Worth, Texas
Base Bid	\$448,000.00	\$422,000.00	\$392,588.00	\$415,000.00
Alternates:				
No. 1 Deduct	2,323.00	4,200.00	3,245.00	3,500.00
No. 2 Deduct	2,619.00	3,100.00	1,046.00	2,000.00
No. 3 Deduct	1,090.00	2,300.00	3,546.00	No Change
No. 4 Deduct	2,419.00	2,700.00	2,620.00	3,000.00
No. 5 Deduct	12,423.00	15,000.00	8,226.00	10,700.00
No. 6 Deduct	11,976.00	12,000.00	10,997.00	11,500.00
No. 7 Deduct	208.00	350.00	325.00	270.00
No. 8 Deduct	915.00	600.00	1,259.00	1,600.00
No. 9 Deduct	1,418.00	1,100.00	1,301.00	1,370.00
No. 10 Deduct	1,300.00	1,300.00	1,300.00	1,450.00
No. 11 Deduct	916.00	1,600.00	1,505.00	110.00
No. 12 Deduct	-0-	150.00	No Change	No Change
No. 13 Deduct	400.00	400.00	500.00	600.00
No. 14 Deduct	21,000.00	11,000.00	42,950.00	30,000.00
No. 15 Deduct	± 700.00	No Change	± 7,700.00	± 1,500.00
No. 16 Add	5,300.00	5,800.00	5,210.00	5,500.00

Each bidder submitted with his bid a bidder's bond in the amount of 5% of the greatest amount bid

It is recommended by President Harrison, Vice-President Price, and System Administration that a contract award be made to the low bidder, Osborne-Lee Construction Company, Arlington, Texas, as follows:

Base Bid		\$392,588.00
Deductive Alternates:		
No. 3	\$ 3,546.00	
No. 6	10,997.00	
No. 9	1,301.00	
No. 10	1,300.00	
No. 11	1,505.00	
No. 13	500.00	
No. 14	42,950.00	
No. 15	<u>7,700.00</u>	<u>69,799.00</u>
Total Recommended Contract Award		<u>\$322,789.00</u>

The total of this recommended contract award, Architect's Fees thereon, estimated amount of movable furniture and equipment, and miscellaneous expenses is within the appropriation of \$375,000.00 for this project, which involves remodeling of a building of approximately 31,248 gross square feet.

22. DALLAS MEDICAL SCHOOL - REJECTION OF BIDS FOR PIPING CONNECTIONS TO CENTRAL UTILITY PLANT.--In accordance with authorization given at the Regents' Meeting held July 30, 1971, bids were called for and were received, opened, and tabulated on September 2, 1971, for Piping Connections to Central Utility Plant for certain buildings on the Campus of The University of Texas Southwestern Medical School at Dallas.

The estimated cost of this project was \$90,000.00, and because of the extremely high bids received, it is recommended by Dean Sprague and System Administration that all bids be rejected and that bids be called for again after re-examination of the plans and specifications, these bids to be presented to the Board or the Executive Committee for consideration at a later date.

23. GALVESTON MEDICAL BRANCH - AWARD OF CONTRACTS TO DALLAS OFFICE SUPPLY COMPANY, STEWART OFFICE SUPPLY COMPANY, AND LIBRARY BUREAU, DIVISION OF REMINGTON RAND-SPERRY RAND CORPORATION FOR FURNITURE AND FURNISHINGS FOR MOODY MEDICAL LIBRARY.--Specifications for Furniture and Furnishings for the Moody Medical Library at The University of Texas Medical Branch at Galveston were prepared in the Office of Facilities Planning and Construction, and bids were called for, received, opened, and tabulated on August 25, 1971, as shown on the attached tabulation sheet. (Page 17)

It is recommended by President Blocker and System Administration that contract awards be made to the low bidders, as follows:

Base Proposal A - General Office and Lounge Furniture Dallas Office Supply Company, Dallas, Texas		
Base Proposal	\$123,205.33	
Less Alternate No. 1 (Delete Planters) Deduct	<u>8,601.92</u>	\$114,603.41
 Base Proposal B - Library Furniture and Wood Shelving Stewart Office Supply Company, Dallas, Texas		 27,290.34
 Base Proposal C - Library Bookstacks Library Bureau, Division of Remington Rand - Sperry Rand Corporation, Houston, Texas		 550 <u>63,500.00</u> 443 <u>\$205,893.75</u>
 Total Recommended Contract Awards		

The bids of Estey Corporation and John Sjostrom and Company on Base Proposal B were not in accordance with the specifications and, therefore, could not be considered as valid bids, hence, the recommendation of award to Stewart Office Supply Company, the lowest bidder meeting specifications. The estimated cost for the furniture and furnishings for this project was \$205,000.00. However, because of other necessary expenditures out of the Allotment Account for this project, it is further recommended that an appropriation of \$5,000.00 be made to this project from Interest Earned on Private Gifts for the Moody Medical Library.

THE UNIVERSITY OF TEXAS NURSING SCHOOL SYSTEM-WIDE AT AUSTIN

Bids Received at the Office of Facilities Planning and Construction
The University of Texas System, Austin, Texas, at 2:00 P. M., August 19, 1971

Bidder	Base Bid	Alternates								Bidder's Bond
		No. 1 Add	No. 2 Add	No. 3 Add	No. 4 Add	No. 5	No. 6	No. 7 Add	No. 8 Add	
B-F-W Construction Company, Inc., Temple, Texas	\$2,935,900	\$50,000	\$19,800	\$19,800	\$14,500	-\$13,000	+\$13,500	\$4,000	\$9,000	5%
Cates Construction Company, Inc., Dallas, Texas	2,984,000	52,000	20,000	19,600	15,000	- 16,000	+ 24,000	5,000	9,000	5%
J. C. Evans Construction Company, Inc., Austin, Texas	2,714,860	45,233	18,500	18,500	15,500	+ 8,000	+ 12,000	4,500	8,835	5%
Everhard Construction Company, Austin, Texas	2,884,228	48,418	17,835	17,539	5,000	- 8,311	+ 10,811	3,525	9,835	5%
Lawless and Alford, Inc., Austin, Texas	3,092,613	46,175	18,000	18,000	14,000	No Bid	No Bid	3,591	9,500	5%
Stokes Construction Company, San Marcos, Texas	3,037,303	39,700	18,700	18,700	14,700	- 34,700	- 28,700	3,700	8,700	5%
Waco Construction, Inc., Waco, Texas	3,045,500	35,500	21,000	21,000	14,000	- 10,000	+ 25,000	4,500	8,400	5%
Warrior Constructors, Division Paramount Warrior, Inc., Houston, Texas	3,027,000	49,000	19,000	19,000	14,000	- 15,000	- 5,000	6,000	8,000	5%

FURNITURE AND FURNISHINGS FOR HUMANITIES RESEARCH CENTER
THE UNIVERSITY OF TEXAS AT AUSTIN

Bids Received at the Office of Facilities Planning and Construction
The University of Texas System, Austin, Texas, at 2:00 P. M., August 25, 1971

Bidder	Base Bid A	Base Bid B	Base Bid C	Base Bid D	Base Bid E	Base Bid F	Completion Time	Bidder's Bond
Abel Contract Furniture and Equipment Company, Inc., Austin, Texas	\$135,685.54	\$37,811.56	\$ No Bid	\$22,844.50	\$ No Bid	\$ No Bid	90 days	5%
Dallas Office Supply Company, Dallas, Texas	139,978.33	50,137.34	No Bid	36,783.00	4,136.50	4,968.39	150 days	5%
Estey Corporation, Red Bank, New Jersey	-----	-----	7,041.00	-----	-----	-----	90 days	\$400.00
Rockford Furniture Associates, Austin, Texas	139,523.24	49,166.07	No Bid	20,860.00	3,530.00	8,652.50	75 days	5%
Scott-Rice Company, Irving, Texas	145,921.77	48,674.71	No Bid	No Bid	No Bid	No Bid	110 days	5%
Stewart Office Supply Company, Dallas, Texas	139,266.06	50,608.66	No Bid	No Bid	No Bid	No Bid	60 - 90 days 100 - 120 days on Thonet	5%

FURNITURE AND FURNISHINGS FOR MOODY MEDICAL LIBRARY
THE UNIVERSITY OF TEXAS MEDICAL BRANCH AT GALVESTON

Bids Received at the Office of Facilities Planning and Construction
The University of Texas System, Austin, Texas, at 2:00 P. M., August 25, 1971

Bidder	Base Bid A	Deduct Alt. 1 to Bid A	Base Bid B	Deduct Alt. 1 to Bid B	Base Bid C	Deduct Alt. 1 to Bid C	Deduct Alt. 2 to Bid C	Bidder's Bond	Completion Time
Abel Contract Furniture and Equip- ment Company, Inc., Austin, Texas	\$124,138.30	\$7,720.00	\$29,628.47	\$3,402.00	\$85,218.80	\$4,663.44	\$ 9,041.00	5%	90 days
Dallas Office Supply Company, Dallas, Texas	123,205.33	8,601.92	29,465.90	3,382.50	No Bid	No Bid	No Bid	5%	120 days
Estey Corporation, Red Bank, New Jersey	No Bid	No Bid	19,450.00	1,854.00	69,206.00	4,150.10	11,451.00	\$5,000	90 days
Inter Royal Corporation, New York, New York	No Bid	No Bid	No Bid	No Bid	74,165.00	8,500.00	8,700.00	4,500	60 days
Library Bureau, Division of Reming- ton Rand, Sperry Rand Corporation, Houston, Texas	No Bid	No Bid	---	No Bid	63,500.00	3,473.64	3,164.15	5%	90 days
Rockford Furniture Associates, Austin, Texas	123,389.17	8,589.20	27,730.38	2,803.20	79,108.23	4,558.24	4,752.30	5%	75 days
Scott-Rice Company, Irving, Texas	129,951.45	8,450.80	No Bid	No Bid	No Bid	No Bid	No Bid	5%	110 days
John E. Sjostrom Company, Inc., Philadelphia, Pennsylvania	No Bid	---	27,017.00	2,721.00	No Bid	---	---	5%	90-120 days
Stewart Office Supply Company, Dallas, Texas	126,433.76	8,722.56	27,290.34	2,807.19	No Bid	No Bid	No Bid	5%	(110 days - Thonet (60-90 days on bal.

**Medical Affairs
Committee**

MEDICAL AFFAIRS COMMITTEE

Date: September 8, 1971

Time: Following the meeting of the Buildings and Grounds Committee

Place: Main Building, Room 212
The University of Texas at Austin
Austin, Texas

	<u>Page</u> <u>MED</u>
1. U. T. System: Progress Report on the Regional Medical Program of Texas	1
2. Dallas Medical School and System Nursing School: Approval of Certificate Program for Pediatric Nurse Practitioners	2
3. Galveston Medical Branch: Approval of Proposal Related to the U. S. Public Health Service Hospital	3
4. University of Texas System Units in Houston and Galveston Medical Branch: Report on Planning for a Central Food Service Facility and Approval in Principle	3
5. M. D. Anderson: Approval of By-Laws for the Board of Visitors	4
6. Public Health School: Approval of Expanded Program in Environmental Health Including the Approval, in Principle, for Certain Related Activities	11
7. System Nursing School: Nursing Student Scholarships	21

-
1. U. T. System: Progress Report on the Regional Medical Program of Texas. --
- on file
med*

Chancellor LeMaistre requests that representatives of the Regional Medical Program of Texas, for which The University of Texas System is the grantee institution, be allowed to present a progress report to the Board.

The Regional Medical Program of Texas will begin its fourth operational year effective September 1, 1971, and certain related grant allocations and budget materials are reported in the System Administration Docket for this meeting.

Prior to the meeting a written progress report will be mailed to the Board for their information and initial review.

2. Dallas Medical School and System Nursing School: Approval of Certificate Program for Pediatric Nurse Practitioners. --

Revised

Chancellor LeMaistre concurs in the recommendation of Dean Willman, Dean Sprague, and the Health Affairs Council that the Board of Regents approve the establishment of a certificate program for Pediatric Nurse Practitioners. This program will be administered, and the certificates awarded, by the Systemwide Nursing School, with the academic and clinical resources of Southwestern Medical School being used as added support for the program. This certificate program will require Coordinating Board approval, and following approval by the Board of Regents will be submitted to them.

The proposed program has been developed in response to a challenge issued in the 1971 Joint Statement of the American Nurses' Association Division on Maternal and Child Health Nursing Practice and the American Academy of Pediatrics to prepare nurses to function in an expanded role in ambulatory child health care. As set forth in that Statement, Pediatric Nurse Practitioners will be able to:

1. Secure a child's health and developmental history from his or her parent and record findings in a systematic, accurate and succinct form.
2. Be able to evaluate a health history critically.
3. Perform a basic pediatric physical assessment using techniques of observation, inspection, auscultation, palpation and percussion and make use of such instruments as the otoscope and stethoscope.
4. Discriminate between normal and abnormal findings on the screening physical assessment and know when to refer the child to the physician for evaluation or supervision.
5. Discriminate between normal variations of child development and abnormal deviations by utilizing specific developmental screening tests and refer children with abnormal findings to the pediatrician.
6. Provide anticipatory guidance to parents around problems of child rearing, such as: feeding, developmental crises, common illnesses and accidents.
7. Recognize and manage specific minor common childhood conditions.
8. Carry out (and) or modify a pre-determined immunization plan.
9. Identify community health resources and guide parents in their use.

10. Make home visits in view of presenting health problems.
11. Make decisions arrived at prospectively and collaboratively with the physician in addition to decisions involving a level of traditional nursing judgments. Trust and a close state of inter-dependence are essential for this collaborative decision making.

The proposed program contemplates ten (10) students each four month semester, or twenty certified practitioners annually. Two nursing school faculty will be based at the Dallas Medical School, and the annual operating budget is estimated at \$40,000 to be funded from general revenue program development monies.

This proposal has the endorsement and support of the pediatricians in the Dallas area.

In addition, students admitted to the program will be required to be registered nurses holding a baccalaureate degree in Nursing and to have been guaranteed by an employer the opportunity to practice in the expanded role for which they will be prepared.

It is important to emphasize that at all times these pediatric nurse practitioners will work under the immediate direction and supervision of a licensed physician.

3. Galveston Medical Branch: Approval of Proposal Related to the U. S. Public Health Service Hospital. --

System Administration requests approval and permission to submit to the U. S. Public Health Service a proposal by the Medical Branch for operation of the U.S.P.H.S. Hospital in Galveston. This proposal would integrate the facilities and resources of the U.S.P.H.S. Hospital into the operation of the Medical Branch with any cost of remodeling and rehabilitation of facilities to be paid by the U.S.P.H.S. The cost of patient care rendered would be paid for by the U.S.P.H.S. The Medical Branch will create, through this program, a cohesive system of health care services to the population now served by the Public Health Service Hospital. The integration of this facility and these services will facilitate health manpower production and utilization.

4. University of Texas System Units in Houston and Galveston Medical Branch: Report on Planning for a Central Food Service Facility and Approval in Principle. --

System Administration requests permission to report on the initial planning for a central food service facility for The University of Texas System units in Houston and Galveston.

System Administration recommends that the Board approve this concept in principle with the express understanding that any specific commitments will be reported to the Board for their approval.

5. M. D. Anderson: Approval of By-Laws for the Board of Visitors. --
(Pages 4-10)

Chancellor LeMaistre concurs in President Clark's request that the following By-Laws*for the Board of Visitors of the M. D. Anderson Hospital and Tumor Institute be approved by the Board of Regents.

Dr. Clark's letter further explains the need for approval of this document.

Dr. Charles A. LeMaistre
Chancellor
The University of Texas System
Austin, Texas 78712

Dear Doctor LeMaistre:

The Board of Visitors has been engaged for some time in the formulation of a Constitution and By-laws to aid them in their various activities. This document now has been approved by the Board of Visitors and is forwarded to you. With your concurrence, it is recommended that this document be presented to the Board of Regents for approval at the September 1971 meeting.

It is particularly important to have approval at this time in order that we may proceed without delay with appointment of the Associate Members who will assist us in the fund-raising program described at the July 30 meeting of the Board of Regents.

If additional information is needed we will be pleased to furnish it.

Sincerely yours,

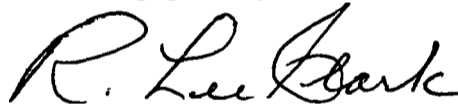

R. Lee Clark, M.D.
President

RLC:br
cc: Dr. William H. Knisely
Mr. E. D. Walker
Copy attached for Miss Thedford

Enclosures

*Set out on Pages 5-10

BYLAWS
of the
BOARD OF VISITORS

ART. I
Nature and Purposes

- 1.1. Nature. The Board of Visitors is an appointive board within the organizational structure of the Anderson Hospital-Institute and the University Cancer Foundation, which assists the President, and upon request, the Board of Regents in an advisory capacity. The operation, conduct, and control of Anderson Hospital-Institute is by statute vested in the President, and the ultimate responsibility of Anderson Hospital-Institute is by statute vested in the Board of Regents. The Board of Visitors' role is one of harmonious cooperation with the President and the Regents in their designated activities.
- 1.2. Purpose. The purpose of the Board of Visitors is to further the mission of the Anderson Hospital-Institute and the objectives of the University Cancer Foundation by all available means, with emphasis upon public relations, and financial assistance through encouraging gifts, grants, donations and bequests.

The Board of Visitors shall also constitute a development board dedicated to its own unique interests, and through the President and the Board of Regents, shall be responsible for all private-fund development for the Anderson Hospital-Institute. It shall determine its own development needs and shall direct the formulation of plans and the promotion of support for its program.

ART. II
Members

- 2.1. Qualifications. The membership of the Board of Visitors shall consist of persons especially interested in the accomplishment of the mission of Anderson Hospital-Institute and the attainment of the objectives of the University Cancer Foundation.
- 2.2. The Board of Visitors shall consist of not more than 25 members, plus the President and the Chancellor of The University of Texas System, both of whom shall be ex-officio members. Members are expected to attend meetings and actively to support the programs of the

Anderson Hospital-Institute and University Cancer Foundation. In addition to such Regular Members, there may be Honorary Members who have rendered distinguished prior service to the Anderson Hospital-Institute and the University Cancer Foundation and who have been elected to membership by the Board of Visitors upon the recommendation of the President. Honorary Members shall be invited to all meetings of the Board but shall not be entitled to vote.

- 2.3. Appointment. Members of the Board of Visitors shall be appointed by the Board of Regents upon recommendation of the President.
- 2.4. Terms. Members of the Board of Visitors shall be appointed for three year terms. No person shall serve for longer than two consecutive terms, provided that special exception may be made by the Board of Regents in instances where a member has rendered distinguished services to the Anderson Hospital-Institute and the University Cancer Foundation. The terms of Regular Members shall be staggered so that approximately one-third of the members shall serve for the fiscal year beginning September 1, 1971, one-third shall serve for two years beginning on the same date, and one-third shall serve for three years beginning on the same date. Lots will be drawn immediately after September 1, 1971, to determine the remaining terms of members of the Board already serving as such.
- 2.5. Resignation and removal. Any member may resign at any time by written letter to the Chairman of the Board of Visitors and the President, addressed c/o the Anderson Hospital-Institute. Any member of the Board of Visitors may be removed at any time by a vote of a majority of the Board of Visitors.
- 2.6. Voting. Each member of the Board of Visitors shall have one vote on all matters coming before such board.
- 2.7. The Board of Visitors may, without the necessity of confirmation of the Board of Regents, select and appoint as Associate Members of the Board not more than 100 persons interested in the mission of Anderson Hospital-Institute and the attainment of the objectives of the University Cancer Foundation. Their duties shall be to assist the Board of Visitors in the discharge of its responsibilities, including private fund development for the Anderson Hospital-Institute. Associates shall be invited to attend, without vote, one or more meetings of the Board of Visitors each year. They shall serve for one year from the date of appointment and may be reappointed on a year-to-year basis. Procedure for selecting and appointing Associates shall conform to applicable resolutions of the Board of Visitors adopted at one or more of its regular meetings.

ART. III
Meetings

- 3.1. Meetings of the Board of Visitors shall occur at least two times each year, preferably in the Spring and Fall. One such meeting shall coincide with a meeting of the Board of Regents. Other meetings shall be held upon special call of the Chairman or the President.
- 3.2. Notices of meetings shall be issued to the membership as early as feasible, and in any event, at least fourteen days preceding the date of the proposed meeting. Special meetings may be called by the President or the Chairman through telephone notice given at least three days in advance.
- 3.3. Place. Meetings shall be held at a location within the State of Texas or elsewhere as specified in the notice of meeting.
- 3.4. Quorum. Forty per cent of the Regular Members shall constitute a quorum qualified to take action as the Board of Visitors. The vote of a majority of those present shall constitute the decision and the action of the Board of Visitors.

ART. IV
Officers and Committees

- 4.1. Officers. The officers of the Board of Visitors shall consist of a Chairman, a Vice Chairman, a Secretary, and a representative to The University of Texas System Advisory Committee which oversees private-fund development and foundations operating within the System. All such officers shall be Regular Members of the Board of Visitors and shall serve for one year or until their successors are selected but in no case longer than their own term on the Board of Visitors. In addition there may be an Assistant Secretary designated by the President from the staff of Anderson Hospital-Institute. It is expected that all officers shall reside in the general area of Houston, Texas.
- 4.2. Duties. It shall be the duty of the Chairman to plan and organize the affairs and meetings of the Board of Visitors in cooperation with the President, so that maximum accomplishments may be achieved; to study the activities, common needs and programs of Anderson Hospital-Institute and the University Cancer Foundation, so that periodic reports and recommendations may be made to the Board of Visitors; he shall preside at all meetings of the Board of Visitors. The Vice Chairman shall perform the duties of the Chairman in his absence or during his disability. The Secretary shall cause notices of all meetings to be issued, cause minutes of all meetings to be kept in a permanent form, and cause all reports required of the Board of Visitors to be prepared. All officers shall perform such additional duties as may be assigned to them by the Board of Visitors from time to time.

- 4.3. Vacancies. In the event of the death, resignation, disability or removal of any officer, the President shall be authorized to make interim appointments until the next meeting of the Board of Visitors.
- 4.4. Executive Committee. There shall be an Executive Committee, composed of those members, resident in Houston, who have been nominated thereto by the Membership Committee with the advice and consent of the President, and elected by the Board of Visitors. The members thereof shall hold office for one year and until their successors are elected and have qualified. The Executive Committee, subject to such limitations as the Board of Visitors shall establish from time to time, shall have and may exercise all of the authority of the Board of Visitors, except that such committee shall have no powers (a) in areas withdrawn from its scope of authority by the Board of Visitors, (b) to elect or appoint directors, officers or members of any committee, (c) to alter, amend, or repeal these bylaws, or any resolutions of the Board of Visitors, or (d) take any action contrary or inimical to any resolutions of the directors, resolutions of the Board of Regents, or any determination of the President. Meetings of the Executive Committee shall be held at such time and place as the Chairman or the President may determine. Three days telephonic notice of meetings of the Executive Committee shall be required, and a majority of the members of the committee shall constitute a quorum for the transaction of business. Minutes of all such meetings shall be kept and shall be presented to the Board of Visitors at its next meeting for approval or disapproval. If time permits, members of the Board of Visitors, non-resident in Houston, shall be invited to Executive Committee meetings and, when present, may participate fully in the deliberations of the Executive Committee, including voting on any question submitted for vote.
- 4.5. Membership Committee. There shall be a Membership Committee consisting of three members of the Board of Visitors nominated by the Chairman with the advice and consent of the President and elected by the Board of Visitors. Members thereof shall hold office for one year and until the successors are elected and qualified. It shall be the duty of the Membership Committee to (a) recommend to the Board of Visitors the names of prospective new members of the Board of Visitors, (b) to make such examination of persons suggested by individual members of the Board of Visitors, or otherwise as may be necessary in order to make such recommendations, and (c) in cooperation with the President and the Chairman, to make nominations with respect to new officers and new members of the Executive Committee. The Membership Committee shall approve and recommend as prospective new members of the Board of Visitors, (1) only persons who have, or who give evidence of having, a special interest in the furtherance of the mission of Anderson Hospital-Institute and the University Cancer Foundation, and (2) only persons who, by profession, avocation, proclivities and residence, will tend to give to the Board of Visitors the broadest possible representation of the whole spectrum of social, cultural and financial characteristics of the people of the State of Texas.

4.6. Finance Committee. There shall be a Finance Committee consisting of five members of the Board of Visitors, to hold office for one year and until their successors shall be appointed. It shall be the responsibility of the committee to assist the Board in the following areas:

- a. Study total development needs of the Anderson Hospital-Institute.
- b. Co-ordinate and formulate plans and actively promote support for both current and long-range programs to meet the developmental needs of the Anderson Hospital-Institute.
- c. Develop gift possibilities not related to pre-terminated projects.
- d. Make periodic reports to the President on the plans and programs of the developmental aspects of Anderson Hospital-Institute, including collection and dissemination of information regarding gifts and endowments.

ART. V Amendments

5.1. Changes. These bylaws may from time to time be added to, changed, altered, amended or repealed (a) by the affirmative vote of at least a majority of the whole Board of Visitors after affirmative recommendation by the President: (b) by affirmative action of the Board of Regents.

ART. VI Definitions

6.1. Definitions. As used herein --

"Regents", or "Board of Regents" means the Board of Regents of The University of Texas System serving at the particular time;

"Anderson Hospital-Institute" means The University of Texas M. D. Anderson Hospital and Tumor Institute;

"President" means the President of The University of Texas M. D. Anderson Hospital and Tumor Institute; and

"Mission of the Anderson Hospital-Institute" means, as set out in the Institutional Plan for The University of Texas M. D. Anderson Hospital and Tumor Institute, approved on November 7, 1957, by the Board of Regents, following:

"Section A. The mission of the Anderson Hospital shall be:

- "1. Research activities. The instigation, conduct, sponsorship and espousal of investigations and research designated to increase the knowledge of mankind relating to the causes, occurrence, treatment, relief, cure and prevention of neoplastic and allied diseases.
- "2. Educational activities. The dissemination to students, the medical and related professions, and the public, of information concerning the occurrence, causes, treatment, relief, cure and prevention of neoplastic and allied diseases, including affiliation with, and participation in, all appropriate teaching functions of The University of Texas.
- "3. Patient care activities. The admission of patients having or suspected of having a neoplastic or allied disease, for the purpose of diagnosing, observing, treating, curing and preventing such conditions."

"Section B. Integration of activities. Notwithstanding the separate enumeration of the activities of the Anderson Hospital in this Article Two, such activities shall be coordinated so that the knowledge gained in the pursuit of one activity shall be brought to bear in the performance of all other activities."

6. Public Health School: Approval of Expanded Program in Environmental Health Including the Approval, in Principle, for Certain Related Activities. --(Pages 11-21)

Referenced

The Material Supporting the Agenda for the Board meeting on June 4, 1971, (Medical Affairs pages 19-24) contained a request by Dean Stallones for the approval, in principle, of plans related to the South-North Center for Health Studies, and the Pan-American Center for the Environment as activities related to the already approved and established Institute of Environmental Health. Board action on this request was deferred for additional clarifying information.

Set forth below on pages 12-14 is a further report from Dean Stallones which outlines the importance of the Institute of Environmental Health to the mission of the School of Public Health, and the advantages to these programs which would accrue from the availability of the Pan-American Center for Human Ecology and Health and the South-North Center for Health Studies. Also set forth on pages 15-21 is a "Proposal for the Pan-American Center for Human Ecology and Health" which has been developed at the request of the Director of the Pan American Health Organization to detail the advantages of a cooperative relationship with the School of Public Health.

Chancellor LeMaistre concurs in the request of Dean Stallones that the Board of Regents approve:

1. In principle, the development of the Pan American Center for Human Ecology and Health and the South-North Center for Health Studies as cooperative aspects of the Institute of Environmental Health.
2. Appropriate activities by Dean Stallones and his staff to develop these Centers and to seek financial support for them.

Not approved

-3.

PROPOSED DEVELOPMENT OF THE PROGRAM IN ENVIRONMENTAL HEALTH
OF THE SCHOOL OF PUBLIC HEALTH AT HOUSTON

During the decade of the sixties, problems of environmental deterioration have become increasingly more evident. This trend will continue through the seventies and beyond so long as populations expand and the per capita production and consumption of goods and energy and concomitant waste products escalate with advances in technology. 'Environment' and 'ecology' have become key words in major issues influencing political and social decisions about environmental concerns at all levels of government. These issues relate directly to the effective utilization of limited resources available to governmental and political subdivisions in the solution of environmental problems.

Of particular significance are the implications of resultant actions on the functions of public agencies concerned with a people's health and well-being. Organized public health structures have yet to rise to the full challenge of environmental change. Public health agencies must define more clearly and effectively trends and projections of environmental change, and must adapt the content of programs and administrative patterns and processes to cope effectively with imminent health hazards. This is an extremely difficult task requiring substantial reorientation of current perspectives, strategies, and health practices.

If a university is to fulfill its responsibility, it must serve as a center of inquiry into the solutions to these problems as well as a place where students may prepare themselves to deal with the next generation of problems. The School of Public Health shares special responsibility in this field with other components of The University

of Texas System, and the establishment of the Institute of Environmental Health within the School of Public Health reflected a recognition of this responsibility.

Within the past few months, we have been apprised of the willingness of staff of the Pan American Health Organization to consider locating a new research and study activity, The Pan American Center for Human Ecology and Health, in conjunction with our Institute of Environmental Health. This offers us the opportunity to greatly strengthen our program. At the request of the Director of PAHO, we have prepared a plan for this center, a copy of which is attached. We expect to organize the Institute of Environmental Health of our school in parallel fashion:

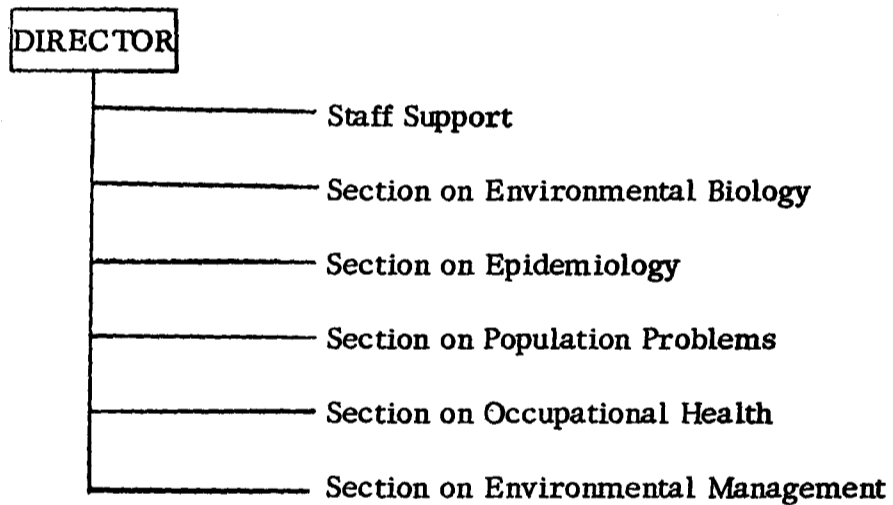

This seems to us a most desirable pattern to use the existing strengths of the School of Public Health in order to achieve the objectives of both organizations as rapidly as possible.

In addition to, and closely related to the development of the activities in environmental health, we would like to create a South-North Center for Health Studies. We envision this to be a bi-lingual organization offering facilities for individuals and small groups to study various aspects of health and disease. For example, it could be the base of operations for a physician who wished advanced training in cancer therapy at the M. D. Anderson or a group of students concerned with the economics of medical care. We would encourage faculty members from Latin American Universities to come to the center for intensive study with a colleague from a university in the United States. At some stage we would hope to have residential facilities, library, study spaces and conference rooms. A facility such as this would be very attractive for Spanish-speaking United States nationals as well as people from Latin-American countries. The value of such a center in promoting international amity as well as scholarship in the field of health should be very great.

7.

System Nursing School: Authorization to Dean Willman to
Certify Nursing Students for Scholarships to be Funded by
S.B. No. 11 as Amended by S.B. No. 7, 1st Called Session,
an Appropriation of the 62nd Legislature. --Dean Willman

was authorized to certify the nursing students of The University of Texas Nursing School (System-wide) eligible to receive scholarships authorized under Senate Bill No. 11, Acts of the 62nd Legislature, R. S. , 1971, as amended by Senate Bill No. 7, Acts of the 62nd Legislature, First Called Session, 1971, and to specify the amount of each scholarship which shall include tuition, laboratory fees, building use fees, and required student services fees.

Take out 2nd
Sentence
Art III, 3.1

PROPOSAL FOR THE
PAN AMERICAN CENTER FOR HUMAN ECOLOGY AND HEALTH

1. INTRODUCTION: This is a proposal for the establishment of a center for the study of the relationship of human health to environmental change. The center is planned to conduct and promote research in this area of man-environmental relations in the region of the Americas; to gather, evaluate, and disseminate information; to assist in the training of persons to work with environmental problems; and to provide consultation services.

2. OBJECTIVE: This center is intended to complement and supplement all of the relevant existing centers maintained under the auspices of the Pan American Health Organization; i. e., the Center for Sanitary Engineering and Environmental Sciences in Lima, Peru; the Center for the Study of Zoonoses in Buenos Aires, Argentina; the Aftosa Center in Rio de Janeiro, Brazil; and the centers devoted to problems of nutrition in Guatemala City and Jamaica. Through PAHO, this center will maintain liaison with the Economic Commission for Latin America, the Inter American Development Bank, and other agencies concerned with economic and social development and environmental problems in the Americas.

2.1 The center is to work to improve the adaptation between man and his environment, by reducing the destructive impact of human activities on natural environments, by promoting environmental management methods that balance conservation with human needs, and by exploring more deeply the health consequences of rural and urban development. The objective is to achieve a harmonious and healthful balance between the need to provide for our present populations and the need to bequeath a productive environment to succeeding

generations. We must achieve an acute awareness of the limitations of our environment, of the responsibilities of our trusteeship, and of the necessity to adopt a managerial rather than an exploitative approach.

2.2 After the center is established, it will soon develop an identity of its own and its distant development cannot be charted precisely at this time. The center should remain flexible enough at this stage of planning to respond appropriately to problems which cannot now be envisioned.

2.3 Emphasis in this center will be placed especially on biological relations in the environment that affect human health, that is, the complex of interactions between man and the physical and biological components of the environment. This is an approach which will supplement, not duplicate nor supplant, the activities of other PAHO centers, and, indeed, has not been pursued in a comprehensive fashion anywhere.

3. THE PROPOSED STRUCTURE

3.1 Staff Support Services: In addition to the requirements for personnel and business management, the support services will include extensive resources relating to the gathering, evaluation, and dissemination of information. The heavy flow of information must be assembled in a centralized location in order to be used efficiently. The mass is so great that it must be screened and summarized before it is truly available to those who need it. A variety of methods have been proposed for more effective storage and retrieval of information and these need to be studied and tested.

3.2 Section on Environmental Biology: The activities of this section will be based on human and animal ecology and on human adaptation to environmental

stresses.

3.3 Epidemiology: All epidemiologic study relates to environmental circumstances, but the customary approach has been to focus sharply upon a disease. While not renouncing that approach, we believe an environmental orientation will provide a fresh and rewarding point of attack. To some extent, the concepts of Pavlovsky, applied in practice in the USSR, reflect a concentration on environmental circumstances, but these concepts were limited to infectious diseases and especially the zoonoses. It is believed that the environment should be considered more broadly, to include social patterns and structures. Further, the emphasis should not be placed just on where and how a particular disease might be expected, but on how environments may be classified according to the disease patterns characteristic of them, and how diseases may be more usefully classified by their association with defined environments. Especially important is the development of our understanding of the relations between the occurrence of illness and environmental change.

3.4 Population Studies: At the core of concern with human ecology is demography, the study of the determinants of population distribution and density. The most serious threat to the integrity of the environment is the pressure of the expanding human community. The increasing rate of consumption of non-renewable resources, the heavy burden of competition between people for food and space, and the limited capacity of the environment to accept waste products are all direct functions of population growth and distribution.

3.5 Occupational Health: One of the most significant determinants of human health is the occupational environment. Often highly artificial, a working situation

may impose extraordinary stresses for prolonged periods of exposure. The very artificiality of such environments may mean that they are readily subject to manipulation in the interest of health.

3.6 Environmental Management: Once the concept is adopted that the role in relation to the environment broadly is one of husbandman rather than exploiter, much conflict can be resolved. Conservation, expressed from an extreme point of view, has often seemed to imply the preservation of some existing situation at all costs. This kind of conservationist can hardly be aware of the slow ebb and flow of biological species under the stress of massive natural environmental change. On the other hand, wanton destruction of natural resources for immediate gain threatens the survival of the human species. We must learn to view the planet as a system and our goal must be to derive a sustained yield from the system. To achieve this, concerted social and political action is necessary and our instruments of government must become environmental managers. The study of the role of management as a social, political, and legal process is necessary and this is expected to become an important part of this center.

4. AFFILIATION WITH THE UNIVERSITY OF TEXAS

4.1 The center should be located in Houston, Texas, closely affiliated with the School of Public Health of The University of Texas. The reasons are:

4.1.1 Direct involvement of institutions in the United States in inter-American health activities should be expanded. An institution such as the one proposed here promises great benefit to the host country as well as the other American States, both in substantive technical advances and in improved understanding and appreciation of each others problems.

4. 1. 2 A large University base offers many advantages over a free-standing agency. The breadth of environmental problems requires a contribution from a vast array of different disciplines, and a University provides a setting where such an array is already assembled and where some channels of communication already exist.

4. 1. 3 Within a University, the sponsorship for a center concerned with environmental health might be sought in a school of engineering, or a school of medicine, or a school of public health. We suggest that schools of engineering and schools of medicine represent too highly concentrated emphasis on either environmental or health aspects to allow the development of a balanced approach to environmental health. Not only are these concerns blended together in a school of public health, but there is found the necessary emphasis on community approaches to problems.

4. 1. 4 In The University of Texas School of Public Health a sound basis for the pursuit of solutions to problems of community health has been established by forming inter-disciplinary units of faculty and students. The Institute of Environmental Health was made an integral part of the School of Public Health by the Board of Regents of The University of Texas. The purpose of the Institute is to extend the research and service activities of the faculty. Within the School of Public Health currently plans are under way to develop a South-North Center for Health Studies. This will be a multi-lingual center to promote interchange of students and scholars. The convergence of these offers a splendid opportunity for cooperation with the proposed Pan American Center for Human Ecology and Health.

4.2 Should the PAHO center be established in Houston, The University of Texas components in Houston can offer a nucleus of staff which will allow the center to begin operations immediately and develop at an optimal rate. The following faculty members have indicated their interest in the program and their willingness to devote substantial time and effort to the center.

4.2.1 Environmental Biology

Leslie A. Chambers, Ph.D., Professor of Environmental Health, a biologist with extensive background in air pollution.

Carl Hacker, Ph.D., Assistant Professor of Medical Zoology.

John Scanlon, Ph.D., Professor of Medical Zoology.

Michael Smolensky, Ph.D., Assistant Professor of Environmental Physiology.

James H. Steele, D.V.M., Professor of Environmental Health.

He will become the Director of the Institute of Environmental Health.

4.2.2 Epidemiology

Darwin R. Labarthe, M.D., M.P.H., Associate Professor of Epidemiology, a physician-epidemiologist.

Reuel A. Stallones, M.D., M.P.H., Dean and Professor of Epidemiology.

4.2.3 Population Studies

Ralph F. Frankowski, Ph.D., Associate Professor of Biometry.

Robert E. Roberts, Ph.D., Associate Research Demographer.

4.2.4 Occupational Health

Valiant C. Baird, M.D., Professor of Occupational Health.

James H. Sterner, M.D., Professor of Environmental Health,

a physician, industrial medicine.

4.2.5 Environmental Management

Arthur A. Atkisson, D.P.A., Professor of Health Administration, formerly director of research for the Los Angeles County Air Pollution Control District and Director of the Institute of Urban Ecology of The University of Southern California.

George M. Walker, Jr., Ph.D., Associate Professor of Health Services Administration.

4.3 Thus, through joint appointments, the staff of the PAHO center and the faculty involved in the Institute of Environmental Health can develop a stronger program more rapidly than either could do alone.

System Nursing School: Nursing Student Scholarships. --

The Appropriations Bill passed by the Sixty-second Legislature appropriates to The U.T. Nursing School for the year 1971-72 an amount of \$130,000 out of the General Revenue Fund for "nursing scholarships pursuant to S.B. No. 908, Acts of the Sixty-second Legislature."

S. B. No. 908 provides that "The governing boards of Texas Woman's University, The University of Texas System, Prairie View Agricultural and Mechanical College, and West Texas State University may grant nursing tuition scholarships to students enrolled in a baccalaureate nursing program. Each such scholarship shall be granted only after a review of the economic circumstances and need of the individual student and may be in an amount deemed necessary to cover any part, or all, of the tuition of such student. Each such governing board may prescribe rules, regulations, and the conditions of the general effect applicable to the awarding of nursing tuition scholarships."

In compliance with the above provisions, System Administration recommends that the Dean of The University of Texas Nursing School be authorized to certify the nursing students to receive such scholarships and the amount to be awarded to each student. Such scholarships may include all or part of the required charges for tuition and fees. These charges include tuition, laboratory fees, building use fees, and required student services fees.

L&I Com.

LAND AND INVESTMENT COMMITTEE

Date : September 8, 1971
Time : Following the meeting of the Medical Affairs Committee
Place : Main Building, Room 212
U. T. Austin

PERMANENT UNIVERSITY FUND

Page
L & I

INVESTMENT MATTERS:

1. Recommendation for Designation of Capitol Mortgage Bankers, Inc., as Seller-Servicer for FHA Mortgage Program. 2
2. Report on Clearance of Monies to Permanent University Fund and Available Fund for the Current Fiscal Year Through July, 1971. 3

LAND MATTERS:

3. Easements Nos. 3297 through 3309 4
4. Material Source Permit No. 392 5
5. Water Contract No. 139 5
6. Recommendation Re Re-Survey of Block L, University Lands, El Paso County, Texas 6

TRUST AND SPECIAL FUNDS

GIFT, BEQUEST AND ESTATE MATTERS:

7. U.T. System - Recommendation for Acceptance of Bequest Under the Will of Alma Idell Carlson and for Oil, Gas and Mineral Lease on Tracts in Hidalgo, County. 6
8. U.T. Austin - Carl Stone Benedict Scholarship Fund--Recommendation for Appropriate Action in the District Court of Travis County For Resignation of Individual Trustees, Appointment of the Board of Regents as Successor Trustee and Clarification of Certain Provisions of the Trust Agreement. 7
9. Dallas Medical School - Recommendation for Acceptance of Bequest Under the Wills of Richard M. and Elma Lane Jacks. 8

REAL ESTATE MATTERS:

10. U.T. Austin - Brackenridge Tract - Recommendation for Settlement of Boundary Line Dispute with F.W. Bulian. 8
11. U.T. Austin - Thomas S. Maxey Professorship in Law - Recommendation for Oil and Gas Lease on Tract in Gaines County to Stanley S. Beard. 9

12. U. T. Austin - Thomas S. Maxey Professorship in Law - Recommendation on Sale of 1,127 Acres in Gaines County by Sealed Bids. 9
13. U.T. Austin - Hogg Foundation - Recommendation for Joinder in Two Easements to City of Houston on Memorial Park Property. 10
14. U. T. Austin - McDonald Observatory - Lease Agreement With G. C. Mitchell Estate, Presidio County, Texas - Recommendation Re Sub-Lease Renewal of Grazing Lease to Hayes Mitchell, Jr. 10
15. U.T. El Paso - Josephine Clardy Fox Estate - Recommendation of Lease to Lloyd E. Innerarity on a Portion of Tract 36-A, Elijah Bennet Survey #11, El Paso, Texas. 10

BOND MATTERS:

16. U.T. System - Recommendation Re Sale of Tuition Revenue Bonds, Series 1971. 11

OTHER MATTERS: 

17. Report of Securities Transactions for Permanent University Fund and for Trust and Special Funds for the Month of July 1971 11

TRUSTEES OF WINEDALE STAGECOACH INN FUND

- Waiver of Nepotism Rule 12

PERMANENT UNIVERSITY FUND - INVESTMENT MATTERS.--

1. RECOMMENDATION FOR DESIGNATION OF CAPITOL MORTGAGE BANKERS, INC. AS SELLER-SERVICER FOR FHA MORTGAGE PROGRAM.--It is recommended by the Associate Deputy Chancellor for Investments, Trusts and Lands that the following application for designation as Seller-servicer from whom FHA mortgages may be purchased be approved, and that authority be granted for the appropriate University officials to execute an agreement with such applicant on the form heretofore approved by the Board of Regents:

Austin

Capitol Mortgage Bankers, Inc.
1901 North Lamar Blvd.
Austin, Texas 78701
J. N. Wallace, Chairman of the Board and Director
Joe T. Ogden, President and Director
Total Servicing \$51,520,419.06
Net Worth \$ 326,796.00

PERMANENT UNIVERSITY FUND - INVESTMENT MATTERS. --

2. REPORT ON CLEARANCE OF MONIES TO PERMANENT UNIVERSITY FUND AND AVAILABLE FUND.--The Auditor, Auditing Oil and Gas Production, reports the following with respect to monies cleared by the General Land Office to the Permanent University and Available University Fund for the current fiscal year through July, 1971, as follows:

<u>Permanent University Fund</u>	<u>July, 1971</u>	<u>Cumulative This Fiscal Year</u>	<u>Cumulative Preceding Fiscal Year (Averaged)</u>
Royalty - Oil	\$ 1,417,315.07	\$ 14,696,724.53	\$ 13,688,629.79
Gas - Regular	218,679.65	2,204,970.69	1,258,791.27
- F. P. C.	1,775.67	26,869.20	95,894.92
Water	10,950.63	100,469.68	102,284.60
Salt Brine	1,627.53	13,370.21	11,196.13
Rental on Mineral Leases	3,744.35	265,051.96	270,468.66
Rental on Water Contracts	250.00	26,317.07	25,704.91
Rental on Brine Contracts	100.00	400.00	183.37
Amendments and Extensions of Mineral Leases	6,006.00	427,067.78	210,123.87
	<u>\$ 1,660,448.90</u>	<u>\$ 17,761,241.12</u>	<u>\$ 15,663,277.52</u>
Bonuses, Mineral Lease Sales, (actual)	<u>-0-</u>	<u>1,407,000.00</u>	<u>1,736,500.00</u>
 Total - Permanent University Fund	 <u>\$ 1,660,448.90</u>	 <u>\$ 19,168,241.12</u>	 <u>\$ 17,399,777.52</u>
 <u>Available University Fund</u>			
Rental on Easements	\$ 25,639.95	\$ 164,358.80	\$ 170,181.00
Interest on Easements and Royalty	1,574.20	2,248.27	5,520.02
Correction Fees-Easements	-0-	-0-	-0-
Transfer and Relinquishment Fees	198.54	4,515.45	9,348.79
	<u>\$ 27,412.69</u>	<u>\$ 171,122.52</u>	<u>\$ 185,049.81</u>
 Total-Permanent and Available University Funds	 <u>\$ 1,687,861.59</u>	 <u>\$ 19,339,363.64</u>	 <u>\$ 17,584,827.33</u>

Oil and Gas Development - July 31, 1971
Average Under Lease 532,038
 Number of Producing Acres 320,232
 Number of Producing Leases 1,421

PERMANENT UNIVERSITY FUND - LAND MATTERS.--

3. LEASES AND EASEMENTS.--It is recommended by the Associate Deputy Chancellor for Investments, Trusts and Lands that the following applications for various leases, easements, assignments, amendments, material source permits and water contracts on University Lands be approved. All have been approved as to form and as to content by the appropriate officials.

EASEMENTS AND SURFACE LEASES

All easements and surface leases are at the standard rates; are on the University's standard forms; and payment has been received in advance, unless otherwise stated.

No.	Company	Type of Permit	County	Location (Block #)	Distance or Area	Period	Consideration
3297	Dorchester Gas Producing Company	Pipe Line	Reagan	8 - 9	366.61 rds. 4½ inch	3/1/71- 2/28/81	\$ 238.30
3298	Amoco Production Company (Renewal of 1611)	Pipe Line	Andrews	13	1284.5 rds. Various size	9/1/71- 8/31/81	1,348.36
3299	Humble Oil & Refining Company	Pipe Line	Ward	16	413.3 rds. 3½ inch	6/1/71 5/31/81	268.65
3300	Amoco Production Company (Renewal of 1602)	Pipe Line	Andrews	11	418.4 rds. 18-24 inch	9/1/71- 8/31/81	836.80
3301	Amoco Production Company (Renewal of 1616)	Pipe Line	Andrews	13	221.9 rds. 6 5/8 in.	9/1/71- 8/31/81	288.47
3302	El Paso Natural Gas Company	Pipe Line	Hudspeth	J	1,040 rds. 4½ inch	7/1/71- 6/30/81	676.00
3303	Union Texas Petroleum (Renewal of 1638)	Pipe Line	Upton	3 - 58	1515.17 rds. 4½ inch	11/1/71- 10/31/81	984.86

L 81-4

Easements and Surface Leases - Continued --

No.	Company	Type of Permit	County	Location (Block #)	Distance of Area	Period	Consideration
3304	Gulf Refining Company (Renewal of 1622)	Pipe Line	Crane	31	1.795 rds. 8 3/4 in.	11/1/71- 10/31/81	\$ 2,333.50
3305	Caroline Hunt Sands, Loyd B. Sands and William Herbert Hunt	Pipe Line	Crockett	32	443.04 rds. 2 1/2 inch	7/1/71- 6/30/81	287.98
3306	David Fasken	Pipe Line	Andrews	4	145 rds. 2 3/8 in.	8/1/71 7/31/81	94.25
3307	Atlantic Richfield Company	Pipe Line	Crane	31	843.89 rds. 4 inch	7/1/71- 6/30/81	548.53
3308	Lo-Vaca Gathering Company	Pipe Line	Terrell	35	786.36 rds. 36 inch	9/1/71- 8/31/81	2,752.26
3309	West Texas Utilities	Power Line	Crane	30 - 31	2,848.48	9/1/71- 8/31/81	1,709.09

4. MATERIAL SOURCE PERMIT

No.	Grantee	County	Location	Quantity	Consideration
392	McVean and Barlow, Inc.	Pecos	Block 25	2,270 cubic yards of pad dirt	\$ 681.00

5. WATER CONTRACT

No.	Grantee	County	Location	Period	Consideration
139	Atlantic Richfield Company	Crane	Sections 31-32 Block 30 Section 36, Block 31	7/1/71- 6/30/76	\$1,920.00*

*Ten cents (10¢) per one thousand (1,000) gallons of water produced. The minimum royalty per year shall not be less than \$1,920.00.

PERMANENT UNIVERSITY FUND - LAND MATTERS.--

6. RECOMMENDATION RE RE-SURVEY OF BLOCK L, UNIVERSITY LANDS, EL PASO COUNTY, TEXAS.--At the meeting of the Board of Regents held on April 17, 1970, the Associate Deputy Chancellor for Investments, Trusts and Lands was authorized to negotiate with competent surveyors for the re-survey of Block L, University Lands, El Paso County, Texas. As a result of several conferences with personnel of the General Land Office, the necessary working sketches and other materials which will be required in connection with such re-survey have been assembled. Negotiations are presently in progress with several Licensed State Land Surveyors with the necessary and required experience to perform such surveying work which will result in estimates covering the cost of such survey being received by the Office of Investments, Trusts and Lands prior to the meeting of the Board on September 8, 1971.

The Associate Deputy Chancellor for Investments, Trusts and Lands requests permission to submit the matter of the re-survey of Block L, University Lands, El Paso County, Texas, to the Board for discussion with recommendations for the employment of a surveyor and appropriation for the cost of such survey to be made at said meeting.

TRUST AND SPECIAL FUNDS - GIFT, BEQUEST AND ESTATE MATTERS.--

7. U.T. SYSTEM - RECOMMENDATION FOR ACCEPTANCE OF BEQUEST UNDER THE WILL OF ALMA IDELL CARLSON AND FOR OIL, GAS AND MINERAL LEASE ON TRACTS IN HIDALGO COUNTY.--Miss Alma Idell Carlson (B.S. in Home Economics, U.T. Austin, 1937) of Long Beach, California, died last year. She was born in California but was a resident of Donna, Texas, while attending the University. The residuary section of Miss Carlson's Will is as follows:

"I give, devise and bequeath all of the rest, residue and remainder of my estate, of every kind and character and wheresoever situated at the time of my death, to CORNELL UNIVERSITY, THE UNIVERSITY OF TEXAS, THE UNIVERSITY OF CALIFORNIA AT LOS ANGELES, AND MEMORIAL HOSPITAL OF LONG BEACH, for research in each of said institutions for diseases of the brain and children's diseases, share and share alike."

Administration on the Estate has not been completed, and the University does not yet have details as to what it may receive other than an undivided one-eighth interest in the minerals under three (3) tracts amounting to a total of 105.99 acres in the La Donna Plat Subdivision, Hidalgo County. The Will and Order admitting it to Probate in California have been filed in Hidalgo County.

Lone Star Producing Company proposes an oil, gas and mineral lease on the Hidalgo County acreage at bonus of \$25.00 per acre (\$331.22 for the University), 1/6th royalty, annual delay rental at \$2.00 per acre, and five-year primary term.

The Associate Deputy Chancellor for Investments, Trusts, and Lands recommends acceptance of the bequest and authorization of the lease to Lone Star Producing Company.

8. U.T. AUSTIN - CARL STONE BENEDICT SCHOLARSHIP FUND.--
RECOMMENDATION FOR APPROPRIATE ACTION IN THE DISTRICT COURT OF
TRAVIS COUNTY FOR RESIGNATION OF INDIVIDUAL TRUSTEES, APPOINT-
MENT OF THE BOARD OF REGENTS AS SUCCESSOR TRUSTEE AND CLARIFICATION
OF CERTAIN PROVISIONS OF THE TRUST AGREEMENT.--By deed dated December
28, 1918, Professor H. Y. Benedict (later President of the University 1927-37) and
Mrs. Benedict conveyed to E.C.H. Bantel, J.W. Calhoun, and C.S. Potts and their
successors as Trustees, a piece of Austin real estate to establish the "Carl Stone Bene-
dict Scholarship and Loan Fund," stating that the first \$10,000 would be handled as a
loan fund and anything above \$10,000 would be as an endowment for scholarships. The
instrument states that the three original Trustees and their successors will fill any vacancy
by selection of a successor Trustee. This gift was in memory of their son, Carl Stone
Benedict, who completed one year of outstanding work at the University and then accepted
an appointment to the United States Naval Academy and entered in 1918 where he died
in October of that year from influenza.

The present trustees are Dr. Robert E. Greenwood, Professor of Mathematics,
Dr. Leonardt F. Kreisle, Professor of Mechanical Engineering, and Wm. W. Stewart,
Trust Officer. The Trust Agreement provides for loans or scholarships "to worthy male
students registered in the College of Arts at The University of Texas" with preference
to members of the Sophomore Class, and provides for investment in "safe interest bearing
securities." In line with another provision in the instrument, The University has served
as fiscal agent for the individual trustees.

President Spurr has joined Associate Deputy Chancellor Shelton and the
present Trustees of the Benedict Fund in the following recommendations to the Board of
Regents.

1. That the Board of Regents authorize the University Law Office to
arrange with the Attorney General for appropriate action in the
District Court of Travis County to accomplish the following:
 - (a) The resignation of the individual trustees in favor of the
Board of Regents as Trustee of the Benedict Fund;
 - (b) Clarification of the investment provision of the Trust Agree-
ment so as to allow the Board of Regents to handle the Fund
under the prudent man rule, including addition to the Univer-
sity's Common Trust Fund;
 - (c) Removal of the limitations of scholarships to students in the
"College of Arts"; and
 - (d) For income to be devoted to scholarships and not to loans;
2. That, assuming successful completion of the Court proceedings, the
Board of Regents accept appointment as Successor Trustee and direct
that one-half of the income from the Fund continue to be added to to
endowment account until the endowment account amounts to approxi-
mately \$32,000, after which all income would be available for scholar-
ships;
3. That, in all other respects, the scholarship fund be handled through
administrative channels, including appointment of a Committee of
Award, in line with the wishes of President and Mrs. Benedict as set
out in the Trust Agreement.

Reasons for these recommendations are as follows:

1. Though the University serves as fiscal agent, it is believed that
the recommended changes will afford better investment manage-
ment and benefits to the Fund; and

2. The attorneys believe that the recommended changes, bringing the fund more directly under the State "umbrella", will avoid any problems with The Tax Reform Act of 1969.

9. DALLAS MEDICAL SCHOOL - RECOMMENDATION FOR ACCEPTANCE OF BEQUEST UNDER THE WILLS OF RICHARD M. AND ELMA LANE JACKS.--Under the terms of the last Will and Testament of Richard M. Jacks, who died on April 20, 1971, and his wife, Elma Lane Jacks, who died on April 24, 1971, the residuary estate, after the payment of certain specific bequests, was devised one-half to the Lighthouse for the Blind of Dallas, Texas, and one-half to The University of Texas, Southwestern Medical School Pulmonary Research Fund. The gross estate amounts to approximately \$120,000 with specific bequests amounting to \$25,500. The Dallas Medical School will receive approximately \$45,000 after payment of its share of the costs of administration.

One of the assets of the estates was the home of Mr. and Mrs. Jacks located at 6409 Vickery Blvd., in Dallas, Texas, which has been appraised at \$19,500. The independent executors, Harold F. Massey and Walter B. Oates have received an offer to purchase said home from James G. and Sally E. Loden for the sum of \$20,000. In connection with such sale, the Southwest Land Title Company has requested that the Lighthouse for the Blind and the Board of Regents, the residuary devisees, join in the conveyance of such real estate.

The Associate Deputy Chancellor for Investments, Trusts and Lands, joined by the Administrative Officials of the Dallas Medical School, recommends that the bequest under the Wills of Richard M. and Elma Lane Jacks be accepted and that the appropriate University Officials be authorized to join in the conveyance of the real property on behalf of said estates and to perform any and all necessary acts required or desired in connection with the closing of this estate.

TRUST AND SPECIAL FUNDS - REAL ESTATE MATTERS.--

10. U. T. AUSTIN - BRACKENRIDGE TRACT - RECOMMENDATION FOR SETTLEMENT OF BOUNDARY LINE DISPUTE WITH F. W. BULIAN.--The Brackenridge Tract includes 96.075 acres west of Town Lake and the most southerly portion of this 96.075 acres contains 8.994 acres of land which Mr. F. W. Bulian also claims as his property. The 96.075 acres was surveyed in 1913, 1928, 1940 and 1969 and these surveys showed three different south lines. The survey in 1928 by Homeyer and the 1969 survey by Metcalfe establish the same south boundary line. After the 1940 survey by Frank Friend, the Board of Regents on March 9, 1940, approved a resolution that the boundary line be set on the south line established and monumented by Frank Friend, which would have recognized ownership by Bulian of 4.207 acres of the 8.994 acre tract. On March 15, 1940, Mr. J. H. Walker of The University of Texas wrote to Mr. Friend, with a copy sent to Mr. Bulian, outlining this history of this tract and the actions of the Regents on March 9. Although we have no record of any further action being taken at that time, the copy of that letter being sent to Mr. Bulian naturally gave him cause to anticipate a settlement.

On June 14, 1912, the heirs of Nathan Wood filed for a partitioning of 25 acres of land in Cause No. 28881 and Mr. Bulian claims that the 8.994 acres in dispute were a part of the land belonging to Nathan Wood. Since they had previously been unable to sell the land, Cause No. 28881 was not settled until 1939 by Mr. Bulian's purchasing this property under court order. The micro-films of this case clearly show that the original partition suit covering 25 acres was in error and that only 16.25 acres were involved and a survey by T. A. Jackson is included in these records showing 16.25 acres. Furthermore, the field note description of the 16.25 acres calls for the north line of that tract as being the south line of the University Tract as surveyed by Homeyer. We are convinced that the south line as established by Metcalfe in 1969 and by Homeyer in 1928 is correct and that Mr. Bulian does not have a legal claim to the 8.994 acres.

There is a portion of an old rock fence at the north end of the 8.994 acres, and Mr. Bulian claims that old fence established his north line. There is a wire fence through the middle of the 8.994 acre tract on the line established by Frank Friend, and Friend set concrete "UT" monuments at the east and west ends of that line. There is a wire fence on the south line of the 8.994 acres as established by Homeyer and Metcalfe surveys. There has been no use of this 8.994 acres by Mr. Bulian other than an unauthorized and unpaved road across the tract by which he enters the 16.25 acres that he owns to the south.

The extreme west boundary of the 96.075 acre tract has been well documented for many years and there is no dispute of title along that line. On October 23, 1970, the Board of Regents approved boundary line agreements on the east boundary with Messrs. Trenckmann, Stableford and Stenger. The balance of the property adjoins Lake Austin and Town Lake to the north.

The Associate Deputy Chancellor for Investments, Trusts and Lands recommends that authority be granted for the following:

- (1) Negotiation with Mr. Bulian to secure a boundary line agreement on the Metcalfe and Homeyer line at a consideration not to exceed \$1,000.00, with authority for the appropriate University officials to execute the necessary instruments, or
- (2) Filing of a suit in trespass to try title. If the retention of outside counsel is deemed advisable, the matter will be referred to the Board at a subsequent meeting for approval.

11. U. T. AUSTIN - THOMAS S. MAXEY PROFESSORSHIP IN LAW - RECOMMENDATION FOR OIL AND GAS LEASE ON TRACT IN GAINES COUNTY TO STANLEY S. BEARD.--In October, 1970, the Board of Regents authorized a 90-day oil and gas lease to Mr. Stanley S. Beard of Midland on its one-half interest in a tract of 647 acres, being Section 82, Block G, W. T. R.R. Co. Survey, Gaines County. The University of the South, owner of the other one-half interest, joined in the lease which expired under its terms due to one of Mr. Beard's partners being unable to obtain his share of the capital.

With assurance that he is now ready to drill shortly after authorization by the Board of Regents, Mr. Beard now requests another lease under the same terms as the first - 90-day primary term, no bonus, 3/16ths royalty, and covering rights down to and including 4,000 feet. This lease has been signed by Mr. Beard and by The University of the South.

The Associate Deputy Chancellor for Investments, Trusts and Lands joins the Geologist in Charge, University Lands, in recommending authorization of the proposed lease.

12. U. T. AUSTIN - THOMAS S. MAXEY PROFESSORSHIP IN LAW - RECOMMENDATION ON SALE OF 1,127 ACRES IN GAINES COUNTY BY SEALED BIDS.--On July 30, 1971, the Board of Regents authorized sale of 1,127 acres in Gaines County by sealed bids. This 1,127 acres is owned one-half (1/2) by the Board of Regents of The University of Texas System and one-half (1/2) by The University of the South. The University of the South has given authority for us to accept bids of \$100,000.00 or greater. The sale will be held on September 7, 1971, and the Associate Deputy Chancellor for Investments, Trusts and Lands will report results of the Bids at the September 8, 1971, meeting with recommendations to accept or reject the bids received.

13. U. T. AUSTIN - HOGG FOUNDATION - RECOMMENDATION FOR JOINDER IN TWO EASEMENTS TO CITY OF HOUSTON ON MEMORIAL PARK PROPERTY.--By a series of deeds from 1924 to 1934, the Hogg family conveyed 1,500 acres of the Memorial Park property to the City of Houston "for park purposes only" with the result that the Board of Regents holds most of the reversionary interest to this property under the deed conveying the Will C. Hogg Estate to the University and under the wills of Mike Hogg and Tom Hogg. This has made it necessary for the Board of Regents to join from time to time in easements.

The City now needs an easement on a small strip of .277 acre out of the James Wharton Survey for a sanitary sewer line and on approximately 6,000 square feet in the William White Survey for street purposes. Miss Ima Hogg, Mrs. Alice Nicholson Hanszen, and Mrs. Margaret Wells Markus have executed the two instruments; and the Associate Deputy Chancellor for Investments, Trusts and Lands recommends authorization for joinder as to the Hogg Foundation interest.

14 U.T. AUSTIN - MC DONALD OBSERVATORY - LEASE AGREEMENT WITH G. C. MITCHELL ESTATE, PRESIDIO COUNTY, TEXAS - RECOMMENDATION RE SUB-LEASE RENEWAL OF GRAZING LEASE TO HAYES MITCHELL, JR.--On August 27, 1966, the Board of Regents authorized the leasing of 33,280 acres of land in Presidio County from the G. C. Mitchell Estate to be used for radio-astronomy and related purposes in conjunction with the operation of McDonald Observatory. On December 4, 1970, the Board of Regents authorized the renewal of the grazing lease to Hayes Mitchell, Jr. for one year at 60¢ per acre. Mr. Mitchell has now offered to renew his lease for five (5) years beginning January 1, 1972, at 60¢ per acre on 32,930 acres (33,280 acres less 350 acres used by the University), subject to cancellation in event the University should elect not to renew its primary lease on the land. The Associate Deputy Chancellor for Investments, Trusts and Lands recommends approval of this renewal lease with authority for appropriate University officials to execute the necessary instruments.

15. U.T. EL PASO - JOSEPHINE CLARDY FOX ESTATE - RECOMMENDATION OF LEASE TO LLOYD E. INNERARITY ON A PORTION OF TRACT 36-A, ELIJAH BENNET SURVEY #11, EL PASO, TEXAS.--The Josephine Clardy Fox Estate owns a vacant tract of land containing approximately 45,742 square feet in the 5300 block of El Paso Drive on which Mr. Lloyd E. Innerarity has made the following offer:

- (1) The size of land leased to be approximately 23,000 square feet with frontage on El Paso Drive of 148 feet.
- (2) Initial term of lease to be 10 years at \$250.00 per month.
- (3) Four (4) renewal options of 10 years each with land re-evaluation at end of each 10 years to determine renewal rental (8-1/2% of value) and provisions that new rental shall be no less than prior 10 years rental.
- (4) Subject to Mr. Innerarity working out a sub-lease with General Services Administration which would involve his erecting on office building on the property.

Mr. Innerarity hopes to receive a commitment from General Services Administration by August 31, 1971, for a 15 year sub-lease.

The portion of the property to be leased was appraised in 1970 by Mr. William W. Browning, Jr., M.A.I. for \$28,750.00 and the \$250.00 rental will provide a return of 10.4% of this value. We have based the proposed rental on an 8-1/2% return of a \$30,000.00 valuation for the first five (5) years and an 8-1/2% return on the future maximum valuation of \$40,500.00 for the second five (5) years. The Associate Deputy Chancellor for Investments, Trusts and Lands recommends approval of the proposed lease provided it is firmed up on or before December 1, 1971, with authority for the appropriate University officials to execute the necessary instruments.

TRUST AND SPECIAL FUNDS - BOND MATTERS.--

16. U. T. SYSTEM - RECOMMENDATION RE SALE OF TUITION REVENUE BONDS, SERIES 1971.--The Associate Deputy Chancellor for Investments, Trusts and Lands and Deputy Chancellor for Administration Walker make the following recommendations:

1. That the Board authorize the sale of 30 year U. T. System Tuition Revenue Bonds, Series 1971, in the amount of \$25,000,000, to be secured by a pledge of tuition revenues from all System Component institutions for the 1971-72 and subsequent school years.
2. That authority be granted to invite bids for the purchase of the bonds, the printing thereof, and the paying agency therefor, to be received for submission to the Board at its meeting on October 22, 1971; and
3. That authority be granted to pay the expenses of the funding out of the proceeds of the sale.

OTHER MATTERS. --

17. REPORT OF SECURITIES TRANSACTIONS FOR PERMANENT UNIVERSITY FUND AND FOR TRUST AND SPECIAL FUNDS FOR THE MONTH OF JULY 1971. --The reports of securities transactions for the Permanent University Fund and for Trust and Special Funds for July 1971 were mailed to the members of the Board of Regents on August 20, 1971. The results of the mail ballots will be reported by the Secretary at the meeting of the Land and Investment Committee.

These items were distributed
by Mr. Shelton at meeting. No "Cal"
approval 9/21/71 *Bad*

RE: L & I ITEM 12

12. U. T. AUSTIN - THOMAS S. MAXEY PROFESSORSHIP IN LAW -
RECOMMENDATION ON SALE OF 1,127 ACRES IN GAINES COUNTY BY SEALED
BIDS.--As authorized by the Board of Regents, sealed bids were invited for the
purchase of the surface only of three separate tracts aggregating 1,127 acres of
land in Gaines County, 1/2 interest in which is owned for the above professorship,
and 1/2 by The University of the South. Twelve bids were received and opened
at 10:00 A.M., CDT, in the office of the University Land Agent in Midland, Texas,
and the results are shown on the attached tabulation. The Land Agent, Mr. Carr,
and the Associate Deputy Chancellor for Investments, Trusts and Lands, recommend
that the bid of Robert Jameson of \$24,327.10 for Tract No. 3 be accepted, and
that all other bids be declined, with the deed and any other necessary documents
to be executed by appropriate officers. The University of the South concurs in
this recommendation.

Tract 3 consists of 161 acres, more or less, described as the SE/4 of
Section 48, Block "G", W. T. Ry. Co. Survey, Gaines County, Texas.

BIDS ON LAND SALE

1127 ACRES - GAINES COUNTY

THE UNIVERSITY OF TEXAS SYSTEM AND THE UNIVERSITY OF THE SOUTH

Tabulation of Bids Received
September 7, 1971 - 10:00 A.M., CDT

Bidder	647 Acres Tract 1	320 Acres Tract 2	161 Acres Tract 3
Roy W. Wicker, Jr.	\$42,766.70	\$ 8,350.20	-0-
Robert Jameson <i>Jameson</i>	-0-	-0-	\$24,327.10
Glen B. Payne, M. D.	\$13,587.00	\$ 8,320.00	\$10,062.50
Monty Williams	\$32,350.00	\$16,000.00	\$13,685.00
Charles Medlin	\$ 8,420.00	\$ 8,323.00	\$17,011.00
Gene Lee	-0-	-0-	\$13,765.50
J. E. Meeley, Jr.	\$27,012.25	-0-	-0-
N. M. Saunders	\$40,000.00	-0-	-0-
Loyd Hood	\$ 6,793.50	\$ 3,360.00	-0-
Danny Grant	-0-	-0-	\$ 2,415.00
Claude and Doak Heame	\$26,688.75	\$12,080.00	\$17,871.00
Walter Woods	-0-	\$11,520.00	\$12,236.00

PERMANENT UNIVERSITY FUND - LAND MATTERS.--

Revised Recommendation - L & I 6

6. RECOMMENDATION RE RE-SURVEY OF BLOCK L, UNIVERSITY LANDS, EL PASO COUNTY, TEXAS.--As authorized by the Board of Regents, negotiations have been conducted with the firms listed below with regard to the re-survey of Block L. The Associate Deputy Chancellor for Investments, Trusts and Lands, joined by Deputy Chancellor for Administration Walker and W. R. Long, Trust Officer, recommend that the firm of Freese, Nichols and Esmond, Consulting Engineers, of Odessa, Texas, on their bid not to exceed \$10,500., be employed to conduct this survey, and that the cost therefor be paid, if approved by the Board for Lease, out of the Special 1% Fund (carried as Account No. 87-0200-0000 - For Expenses of Sales of Mineral Leases - Board for Lease of University Lands - Special Fund), or out of the Available Fund if necessary.

The firms with which negotiations were conducted, all of whom had fairly comparable schedules of rates for the various services involved (field work, office work, mapping, setting of monuments, etc.) are listed below with estimates of total cost by each, and guaranteed maximum where the firm was willing to place a ceiling on charges for the completed job:

<u>Firm</u>	<u>Estimated Total Cost</u>	<u>Agreed Maximum</u>
Freese, Nichols and Esmond, Consulting Engineers, Odessa, Texas	\$ 8,500.	\$10,500.
Clifford C. Cool and Associates Midland, Texas	19,000.	No limit
T. O. Wallis, Civil Engineer and Land Surveyor Midland, Texas	10,000.	15,000.
Lance Engineers, Inc. El Paso, Texas	37,500.	37,500.

TRUST AND SPECIAL FUNDS - BOND MATTERS.--

Revised Recommendation - L & I 16

16. U. T. SYSTEM - RECOMMENDATION RE SALE OF TUITION REVENUE BONDS, SERIES 1971.--In general, the plan for financing the buildings at the new component institutions has been to market Tuition Revenue Bonds from time to time as funds were actually needed. It has now been determined it would be much better to sell the bonds in such amount from time to time as to provide funds to cover the amount of construction and other contracts at the time, or before they are awarded. This will avoid the necessity of incorporating in each of such contracts a provision that the contractor will be paid out of the proceeds of bonds, sold, or to be sold. The general plan for the entire program hereinafter outlined is now recommended.

It appears that award of construction contracts for the various components is scheduled somewhat as hereinafter set out:

	<u>Dec. 1971</u>	<u>Jan. 1972</u>	<u>June or July 1972</u>	<u>Thereafter</u>	
Permian Basin					
Construction	\$11,080,000.	\$	\$		\$
Equipment				1-73	960,000.
San Antonio					
Construction		29,425,280.		12-72	2,246,000.
Equipment				1 -73	3,178,720.
Dallas					
Construction			21,175,000.		
Equipment				1 -74	2,857,000.
S.A. Dental					
Construction			2,298,366.		
Equipment				8 -74	6,285,500.
S.A. Nursing					
Construction				12-72	3,400,000.
Equipment				2 -74	300,000.
E. P. Nursing					
Total	1,700,000.				
Houston Med.				1-73 to	
Total - Net				6-75	13,513,828.
	<hr/>	<hr/>	<hr/>		<hr/>
	\$12,780,000.	\$29,425,280.	\$23,473,366.		\$32,741,048.

TOTAL \$98,419,694.

Based on the above requirements, the following general funding plan is recommended:

- Approximately \$70,000,000. to be sold at public bids, in the usual manner, somewhat as follows:

check this >

December, 1971	\$25,000,000.
June or July, 1972	25,000,000.
Thereafter in one or more sales	20,000,000.
	<hr/>
	\$70,000,000.

2. The sale of \$30,000,000. of bonds at the January, 1972, meeting. These bonds will be sold at negotiated private placement. While the maturity schedule will be planned to follow a 30 year pattern, this will be temporary financing. The bonds will be callable at par at any time on 30 days notice, and the entire issue will bear interest for the first two to four years AT SHORT TERM RATES. THESE BONDS WILL BE CALLED AND REFUNDED within some reasonable period (within three years from date of sale say).

*short-term
agree with bond
to call & term
10-13-71*

3. In order to improve the marketability of these bonds it is proposed that they be additionally secured by pledge of an unlimited library use fee to be assessed only if needed against students at the new components.

Approval of the above general plan is recommended by Deputy Chancellor for Administration Walker and the Associate Deputy Chancellor for Investments, Trusts and Lands, and specific authority is requested to implement the sales of \$55,000,000. of the bonds scheduled for the Board's consideration at the December 3, 1971, and January, 1972, meetings. It is requested that authority be granted to reverse the order of sale of the \$30,000,000. private placement and the first \$25,000,000. to be offered publicly should that action be considered advisable by the Deputy Chancellor and the Associate Deputy Chancellor after consultation with bond consultant.

TRUSTEES OF WINEDALE STAGECOACH INN FUND. --



THE UNIVERSITY OF TEXAS SYSTEM

Office of Investments, Trusts and Lands

210 WEST SIXTH, AUSTIN, TEXAS 78701

512/471-5781

August 4, 1971

MEMORANDUM

To: Chancellor C. A. LeMaistre

From: Floyd O. Shelton, Associate Deputy Chancellor for Investments, Trusts and Lands

Re: WAIVER OF NEPOTISM RULE - WINEDALE STAGECOACH INN FUND -
Mr. and Mrs. Lonn W. Taylor

In preparing Winedale appointments for 1971-72 after approval of the budget by the Trustees on July 30, 1971, it has been brought to my attention that the budget contemplates the reappointment of Mr. Lonn W. Taylor as Art Curator and Educational Director, annual salary, \$7,440, and the full-time appointment of his wife, Mrs. Diane Taylor as Clerical Assistant, annual salary \$3,828. Both salaries will be paid from Account Number 38-5000-0100 (charged first to the Salary Account, Number 38-5000-0210), which funds are from the income on the Winedale endowment and admission charges at Winedale.

Mrs. Taylor has been employed part-time for part of the current year. She is quite capable, and her services are needed full-time for cataloguing antiques and art works at Winedale and related duties. She and Mr. Taylor live on the premises, and employing someone else for the work would be quite difficult.

Since Mrs. Taylor works under Mr. Taylor's supervision, I shall appreciate your recommending to the Board of Regents waiver of the nepotism rule.

Secretary-Treasurer, Winedale Stage-
coach Inn Fund

APPROVED:

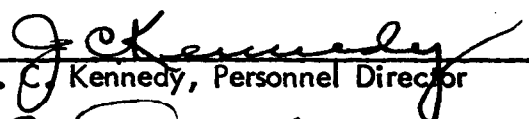
J. C. Kennedy, Personnel Director

E. D. Walker, Deputy Chancellor for
Administration

ddp

Com. of the
Whole

COMMITTEE OF THE WHOLE
Chairman Peace, Presiding

Date: September 8, 1971

Time: Following the meeting of the Land and Investment Committee

Place: Main Building, Room 212
The University of Texas at Austin
Austin, Texas

Page
C of W

I. SPECIAL ITEMS

A. U. T. System

1. Regents' Rules and Regulations, Part Two:
Amendments to Sections 9 and 10 of
Chapter X 2
2. Renewal of Hinson-Hazelwood College Student
Loan Program Agreement 4
3. Award of Contract for System-wide Fire and
Extended Coverage Insurance on Buildings
and Contents Covered by Bond Issues 7

B. South Texas Medical Center

- 3a. Concurrence with San Antonio Medical
Foundation in Sale of Land to Humble
Oil Company 7a

II. RATIFICATION (AFFILIATION AGREEMENTS)

System Nursing School

4. Affiliation Agreement with Brackenridge
Hospital, Austin, Texas, for Clinical
Training for Nursing Students 8
5. Affiliation Agreement with Schlesinger's
Home Health Service Agency, Austin,
Texas, for Clinical Training for Nursing
Students 8

COMMITTEE OF THE WHOLE

**Emergency Items
September 8, 1971**

	<u>Page C of W</u>
8. Board of Regents: Committee and Special Appointments	13
9. U. T. Dallas: Waiver of Regents' Rule to Name Building	13
10. Galveston Medical Branch: Lease of Boat for Use by the Marine Biomedical Institute	14

8. Board of Regents: Committee and Special Appointments. --
Recommendations submitted by letter from Chairman Peace
under date of September 1, 1971.

9. U. T. Dallas: Waiver of Regents' Rule to Name Building. --

Whereas,
Dr. Lloyd V. Berkner, an eminent scientist and educator, was the first
President of the Southwest Center for Advanced Studies; and

Whereas, the founders of this institution wisely chose Dr. Berkner
to direct the establishment of this institution; and,

Whereas, through his leadership, the center attained recognized
academic status and contributed to higher education in Texas; and,

Whereas, through the generosity of the founders and acceptance by
the Legislature of Texas of the land, building and other assets did
establish The University of Texas at Dallas; and,

Whereas, upon recommendation of Regent Williams, The Board of
Regents of The University of Texas System wishes to recognize the con-
tribution of Dr. Berkner by naming a building in his honor; now
therefore,

Be it resolved, that in accordance with Section 1, Chapter VIII,
Part I of the Regents Rules and Regulations, the Board does hereby
officially name the Science-Teaching Building, now under construction
at U. T. Dallas, as the Lloyd V. Berkner Science-Teaching Building.

10. Galveston Medical Branch: Lease of Boat for Use by
the Marine Biomedical Institute. --

President Blocker has been contacted by Mr. H. L. Hering of Houston, acting as agent for Dr. and Mrs. N. C. Leone, with an offer to lease to the Galveston Medical Branch a 35' 10" twin engined boat, more completely described in Mr. Hering's letter dated August 17, 1971. The proposed lease terms are \$1.00 per year "with the understanding that the Medical Branch will provide insurance, storage, all operating costs and maintenance sufficient to keep the boat in its present condition".

President Blocker, in his letter dated August 19, 1971, outlines the advantages to the Marine Biomedical Institute, and especially to the Tektite Program, related to the availability of such a boat. President Blocker estimates that the annual maintenance and operating expenses, including the required insurance, will be \$20,000, which is available from other than State funds, such as the Moody Foundation and federal grants. However, if these fund sources should not be available, some of these expenses could be an appropriate expenditure from the Legislative line-item appropriation to the Marine Biomedical Institute and the Tektite project.

System Administration recommends that the Board of Regents authorize the Galveston Medical Branch to enter into a lease agreement as outlined above with Dr. and Mrs. Leone, subject to the understanding that such boat will be used by the Marine Biomedical Institute for the Texas Tektite Program and for related scientific or engineering programs of Medical Branch and that it will not be used for recreational or pleasure purposes by Medical Branch personnel. It is further recommended that this lease be on an annual fiscal year basis, and that renewals of this initial lease require the approval of System Administration.

See attached sheets for related correspondence.

H. LEE HERING
CERTIFIED PUBLIC ACCOUNTANT
8705 KATY FREEWAY
HOUSTON, TEXAS 77024

MEMBER, AMERICAN INSTITUTE OF
CERTIFIED PUBLIC ACCOUNTANTS

PHONE (713) 467-1729

August 17, 1971

Truman G. Blocker, Jr., M. D., President
University of Texas, Medical Branch
Galveston, Texas

Dear Sir:

Dr. and Mrs. N. C. Leone have requested that I write you to give you the terms of their offer to the University for the use of their boat.

They propose to lease to the University, at the rate of \$1.00 per year, a boat described as follows:

One - 1967 Post Sport Fisherman Boat, 35' 10"
with 2 - 210 HP Chrysler Marine engines-
gasoline. Flying bridge with dual controls,
depth finder and 75-watt ship-to-shore
radio.

This boat is in excellent condition. In the event that the University elects to lease this boat, it would be with the understanding that the University will provide insurance, storage, all operating costs and maintenance sufficient to keep the boat in its present condition. The boat is to be used by the University for research, scientific and educational purposes in association with its official marine biology activities.

Dr. and Mrs. Leone are interested in the University's work. If the University is able to advantageously utilize the boat and will properly care for it, Dr. and Mrs. Leone would give favorable consideration to donating the boat to the University at some later date.

Yours very truly,

H. L. Hering

H. L. Hering

HLH/bm



THE UNIVERSITY OF TEXAS MEDICAL BRANCH
GALVESTON, TEXAS 77550

August 19, 1971

OFFICE OF THE PRESIDENT
PHONE: SO 5-1902

Charles A. LeMaistre, M.D.
Chancellor
The University of Texas System
P.O. Drawer 7969
Austin, Texas 78712

Dear Dr. LeMaistre:

Dr. and Mrs. Nicholas C. Leone of Fort Lauderdale, Florida, have offered to lease to the University of Texas Medical Branch for use by the Marine Biomedical Institute a 35'10" twin engined boat, The Lucie-L, approximate value \$25,000, and presently insured for that amount. The lease would be on a one-dollar per year basis with the understanding that the Medical Branch would insure and properly maintain the boat during the lease period.

This boat would be ideal for use by the Marine Biomedical Institute in carrying out its Texas Tektite Program. During the early planning stages and until such time as a permanent structure is established on the Flower Gardens area, it is necessary to visit the area at frequent intervals to gather data for planning. This data is gathered by a diving survey team. These divers who are engineers and scientists for the most part have thus far been transported to the Flower Garden area in a chartered work boat. These boats are expensive to charter and are not always available in the appropriate time. The frequency of visits to the Flower Gardens area will increase markedly as the program progresses.

While work boats will be required for heavy transportation to and from the Flower Gardens Ocean Research Center during exploration, construction and operation, it is desirable to have a vessel such as the Lucie-L to be used for diver support exploration and safety activities in conjunction with the work vessel operation and for high speed transportation between the shore and the Flower Gardens. The Lucie-L will meet this latter requirement in approximately one-third to one-half the time required for work vessels and at considerably less expense than the charter of aircraft. She would thereby provide safe, economic transportation for scientific and other professional

Charles A. LeMaistre, M.D.
August 19, 1971
Page 2

personnel, as well as delivery of high value and critical items of equipment. The Lucie-L could also provide emergency medical support facility. Her high speed and maneuverability make her ideal for standby and rescue boat operations. She would be ready to retrieve any diver who might be swept away by strong surface currents or who accidentally surfaced while working on the coral reef below. Because of her light displacement, the Lucie-L will enable the Marine Biomedical Institute to reduce the cost of marine operations in those instances where she can be substituted for work boats of heavy displacement and less flexibility. Preliminary estimates include that operation and maintenance costs are \$20,000 annually for year-round operations. These costs will be provided from other than State funds.

I am therefore respectfully requesting your approval and that of the Board of Regents to enter into a lease agreement with Dr. and Mrs. Leone. If possible it would be appreciated if this could be considered as an emergency item for the September 8 Board of Regents meeting.

Sincerely yours,

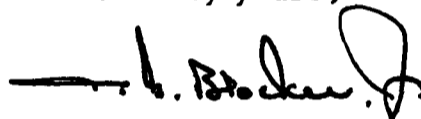

T. G. Blocker, Jr., M.D.
President

TGB:cls

III. ITEMS FOR THE RECORD

A. U. T. Austin

6. Development Board Membership 9

B. M. D. Anderson

7. Approval of Offer of Board of Visitors'
Campaign for Expansion and Development 10

IV. SCHEDULED MEETINGS AND EVENTS 11

A. U. T. System

1. Regents' Rules and Regulations, Part Two: Amendments to Sections 9 and 10 of Chapter X. --

Amended

At the July 30, 1971 meeting, the Board of Regents authorized Chancellor LeMaistre to submit revisions to the Rules and Regulations delegating to President Spurr the approval authority for the minutes and actions of the Texas Union Board and Athletics Council.

The following versions are submitted pursuant to that authorization, and are recommended by President Spurr and Chancellor LeMaistre.

(See attached)

Amend Sections 9 and 10 of Chapter X of Part Two of the Regents' Rules and Regulations as follows:

(1) Amend Subsections 9.5 and 9.11 to read as follows:

9.5 At least two [EIGHTEEN] copies of the minutes of all meetings of the Board of Directors and the Executive Committee shall be delivered promptly to the President of The University of Texas at Austin [FOR DISTRIBUTION TO THE CHANCELLOR, THE VICE-CHANCELLOR FOR ACADEMIC AFFAIRS, THE MEMBERS OF THE BOARD OF REGENTS, THE SECRETARY TO THE BOARD OF REGENTS, AND SUCH OTHER MEMBERS OF THE U. T. AUSTIN ADMINISTRATION AS THE PRESIDENT OF THE UNIVERSITY OF TEXAS AT AUSTIN MAY DIRECT]. No budget or budget amendment adopted by the Board of Directors of the Texas Union, or of any committee or subcommittee of such Board, shall have any force or effect until such budget or budget amendment has been approved by the Board of Regents.

9.11 Notwithstanding any other provision of this section, every action of the Board of Directors of the Texas Union, and every action of any committee or subcommittee of such board, shall be reviewed by the President of The University of Texas at Austin [BOARD OF REGENTS] and the President of The University of Texas at Austin [BOARD OF REGENTS] may approve reverse, or modify each such action. After reviewing the minutes of the Board of Directors, the President of The University of Texas at Austin shall deliver to the Chancellor two copies of such minutes and a copy of the action, if any, taken by the President with regard to the approval, modification, or reversal of any action of the Board of Directors.

(2) Amend Subsections 10.1 and 10.2 to read as follows:

10.1 At least two [EIGHTEEN] copies of the minutes of all meetings of the Athletics Council at The University of Texas at Austin shall be delivered promptly to the President of The University of Texas at Austin. No budget or budget amendment adopted by the Athletics Council, or of any committee or subcommittee of such Council, shall have any force or effect until such budget or budget amendment has been approved by the Board of Regents [FOR DISTRIBUTION TO THE CHANCELLOR, THE VICE-CHANCELLOR FOR ACADEMIC AFFAIRS, THE MEMBERS OF THE BOARD OF REGENTS, THE SECRETARY TO THE BOARD OF REGENTS, AND SUCH OTHER MEMBERS OF THE U. T. AUSTIN ADMINISTRATION AS THE PRESIDENT OF THE UNIVERSITY OF TEXAS AT AUSTIN MAY DIRECT].

10.2 The President of The University of Texas at Austin [BOARD OF REGENTS] shall review the minutes of all meetings of the Athletics Council and may subsequently approve, reverse, or modify any action therein. After reviewing the minutes of a meeting of the Athletics Council, the President of The University of Texas at Austin shall deliver to the Chancellor two copies of such minutes and a copy of the action, if any, taken by the President with regard to the approval, modification, or reversal of any action of the Athletics Council. [THE MINUTES SHALL BE SUBMITTED FOR THIS REVIEW AND FOR THE BOARD'S CONSIDERATION THROUGH THE EXECUTIVE COMMITTEE WHICH SHALL REFER ALL ITEMS RELATING TO POLICY TO THE COMMITTEE OF THE WHOLE AND ALL ITEMS RELATING TO BUILDINGS TO THE BUILDINGS AND GROUNDS COMMITTEE].

2. Renewal of Hinson-Hazelwood College Student Loan Program Agreement. --

Meeting No. 644, July 8-9, 1966, p. 85.

On July 15, 1971, the Coordinating Board adopted revised Rules and Regulations governing loans made under the Hinson-Hazelwood College Student Loan Program and insured under the Federally Insured Student Loan Program. A contract of insurance was signed on July 26, 1971, with the U.S. Commissioner of Education.

System Administration officials have reviewed the new Rules and Regulations concerning this Act and recommend that the Agreement with the Coordinating Board, Texas College and University System for participation in the Hinson-Hazelwood College Student Loan Program (previously known as "Texas Opportunity Plan, a student loan program") be approved, and that the chairman be authorized to execute the agreement.

It is also recommended that Chancellor LeMaistre be authorized to appoint and submit to the Coordinating Board a Texas Opportunity Fund Officer for each of the participating institutions of The University of Texas System as required in section 2 of the agreement.

Following is a Xerox copy of a letter from Ray A. Fowler of the Coordinating Board, Texas College and University System:



**COORDINATING BOARD
TEXAS COLLEGE AND UNIVERSITY SYSTEM
HINSON-HAZLEWOOD COLLEGE STUDENT LOAN PROGRAM
P. O. Box 12788 Capitol Station
Austin, Texas 78711
Area Code 512 475-4147**

July 26, 1971

TO THE PRESIDENT ADDRESSED:

On July 15, 1971, the Coordinating Board adopted revised Rules and Regulations governing loans made under the Hinson-Hazlewood College Student Loan Program and insured under the Federally Insured Student Loan Program. A contract of insurance was signed on July 26, 1971 with the U.S. Commissioner of Education.

CHANCELLOR'S OFFICE U. OF T.

Acknowledged..... File.....

REC'D JUL 26 1971

..... For info and history
..... Please Advise etc.
..... Please notify

Enclosed is a copy of the revised Rules and Regulations together with Appendices A, B, C, and D. The following action should be taken so that your institution may be approved for participation in the program:

- (1) Complete the agreement (Appendix A) and submit it with a sufficient number of copies for your use. The original will be retained by the Coordinating Board.
- (2) Designate, by letter, the full-time administrative official (Texas Opportunity Plan Fund Officer) of your institution who shall serve as the Board's on-campus agent to certify all institutional transactions and activities with respect to the Fund and be responsible for all records and reports reflecting transactions with respect to the Fund.

Loan applications should be submitted to our office for processing in accordance with instructions sent to your Texas Opportunity Plan Fund Officer on June 28, 1971.

Sincerely yours,

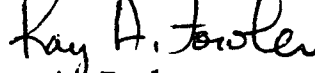

Ray A. Fowler
Deputy Commissioner

Enclosures

cc: Texas Opportunity Plan Fund Officer

Appendix A

AGREEMENT

between

Coordinating Board, Texas College and University System
and

The University of Texas System
(Name of Institution)

As an eligible institution of Higher Education in Texas, it is hereby agreed that in order to participate in the Hinson-Hazlewood College Student Loan Act the institution will:

- 1) Abide by the Rules and Regulations of the Hinson-Hazlewood College Student Loan Act as adopted by the Board on July 15, 1971 and any subsequent revisions thereto.
- 2) Appoint a Texas Opportunity Plan Fund Officer who will exercise reasonable and diligent care and employ accepted business-type procedures in the administration of the Hinson-Hazlewood College Student Loan Act.
- 3) Submit such reports and information as the Commissioner of Higher Education may require in connection with the administration of the Hinson-Hazlewood College Student Loan Act.

- 4) Comply with such procedures as the Commissioner of Higher Education may find necessary to insure the full utilization of the Hinson-Hazlewood College Student Loan Act funds.
- 5) Provide all forms required by the Commissioner of Higher Education; said forms to be approved by the Commissioner prior to their use by the institution.

The Coordinating Board, Texas College and University System agrees that it will provide an adequate number of copies of the Rules and Regulations of the Hinson-Hazlewood College Student Loan Act as adopted by the Board and subsequent revisions thereto within a reasonable length of time after their adoption.

Both parties agree to comply with Title VI of the Civil Rights Act of 1964 which states: "No person in the United States shall on the grounds of race, color, national origin, be excluded from participating in, be denied the benefits of, or be subject to discrimination under any program or activity receiving federal assistance".

COORDINATING BOARD,
TEXAS COLLEGE & UNIVERSITY SYSTEM

The University of Texas System
(Institution)

(Commissioner)

John Peace
(Chairman of Governing Board)

(Date)

(Date)

3. Award of Contract for System-wide Fire and Extended Coverage Insurance on Buildings and Contents Covered by Bond Issues. --

The 62nd Legislature passed S. C. R. 102 and we are no longer required to carry insurance on State buildings and contents; however, this resolution authorizes the Board of Regents of The University of Texas System to take out insurance policies on revenue producing buildings, or those buildings and contents the revenue of which is pledged by the Board of Regents of The University of Texas System for retirement on indebtedness. (Bonds)

We requested proposals from those companies authorized by the State Board of Insurance to do business in Texas that equaled or exceeded the following ratings as shown in Best's Insurance Guide for 1970:

General Policyholders Rating: A+
Financial Rating: AAAAA
Policyholders' Surplus at December 31, 1969:
\$30,000,000.00 or more

We submitted requests for proposals to 23 insurance companies and also to certain insurance agencies and insurance brokers who had requested the information. On an 80 percent coinsurance basis, the sound insurable value of the properties to be covered was \$118,129,021.00.

Proposals were received August 16, 1971 as follows:

INSURANCE COMPANY	INSURANCE AGENCY	3 YEAR PREMIUM
Aetna Casualty and Surety Insurance Co.	Consolidated Insurance Agency - Austin, Texas	\$486,396.00
Aetna Casualty and Surety Insurance Co.	Marsh & McLennan Ins. Houston, Texas	\$530,252.00
Aetna Casualty and Surety Insurance Co.	Time Insurance Agency Austin, Texas	\$482,409.00
Insurance Company of North America	Lew Borden Co.-Ins. Corpus Christi, Texas	\$364,653.00
Insurance Company of North America	John L. Wortham & Son Houston, Texas	\$370,689.00
St. Paul Fire and Marine Insurance Co.	Cravens, Dargan & Co. Houston, Texas Arthur L. Owen Company Dallas, Texas	\$158,293.00

It is recommended by the System Administration that the Board of Regents authorize the Blanket System-Wide Fire and Extended Coverage Insurance Policy for Buildings and Contents covered by Bond Issues and notes for the period September 24, 1971 to September 24, 1974 with St. Paul Fire and Marine Insurance Company on the basis of the proposal submitted through Cravens, Dargan and Company of Houston, Texas by Arthur L. Owen Company of Dallas, Texas. The three year premium for a Texas standard policy is \$158,293.00 based on a three year premium rate of \$0.134 per \$100.00. The premium will be prorated among the institutions covered by this policy.

B. South Texas Medical Center

- 3a. Concurrence with San Antonio Medical Foundation in Sale of Land to Humble Oil Company. --San Antonio Medical Foundation requests the approval of the Board of Regents for the sale to Humble Oil Company a 0.814 acre plat at the corner of Wurzbach Road and Fredericksburg Road.

An agreement entered into by the Board of Trustees of The San Antonio Medical Foundation and the Board of Regents of The University of Texas System dated June, 1961, states as follows:

Pending completion and execution of organizational arrangements endorsed by The Foundation and The University for effective development of the Medical Center, neither party will (a) transfer or bind itself to transfer Medical Center land or the use thereof to any agency except upon conditions agreed to by the other party, nor (b) be a partner to the creation of any organization with power over the Medical Center without the approval of the other party, nor (c) construct physical facilities on Medical Center land or the site for South Texas Medical School without consultation with the other party.

This plot of ground is completely removed from the Medical School and has no value for Medical School purposes. The attached maps indicate its location and description. Pages 7b and 7c.

It is therefore recommended by Dean Pannill and System Administration that Chairman Peace be authorized to execute any and all instruments necessary to comply with the request of the San Antonio Medical Foundation.

*2/10/61
not value.*

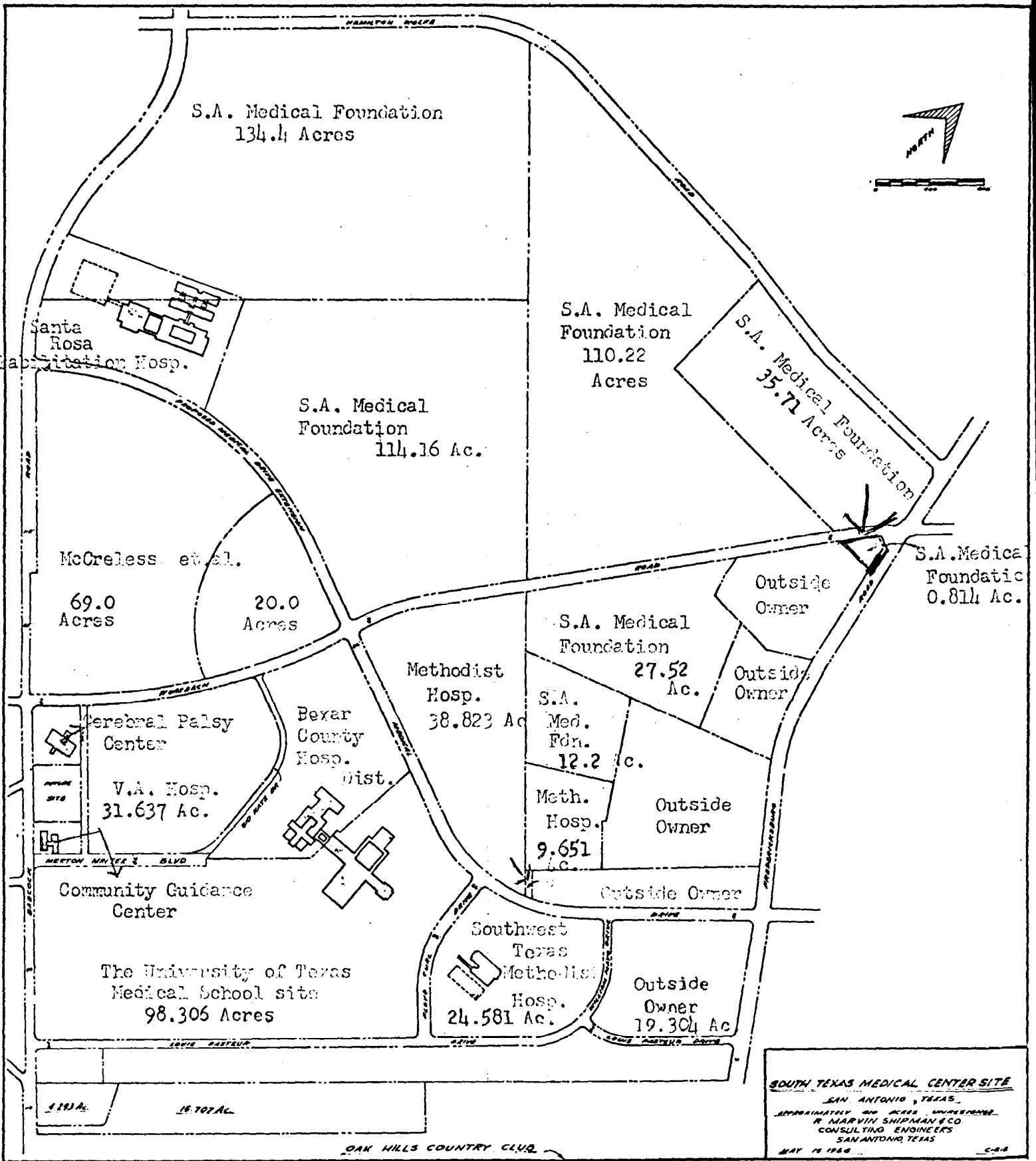

NCB 13663

R = 282.73'
Δ = 5°12'46"
T = 128.45'
L = 256.73'

NORTH

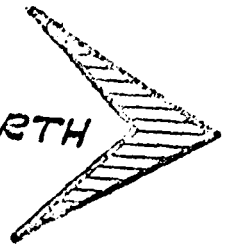

SCALE: 1" = 50'

WURZBACH
(86' R.O.W.)
ROAD

256.73'

0.814 Ac.

S77°46'15"E
90.80'

S14°48'E
171.45'

S 85°33'20" W
285.06'

FREDERICKSBURG ROAD

SKETCH OF

A 0.814 Ac. TRACT OUT OF
N.C.B. 12830

SAN ANTONIO, TEXAS

R. MARVIN SHIPMAN & CO.

CONSULTING ENGINEERS

SAN ANTONIO, TEXAS

JUNE 23, 1970

C-1590

II. RATIFICATION (AFFILIATION AGREEMENTS). --The following affiliation agreements are reported for ratification:

4. System Nursing School: Affiliation Agreement with Brackenridge Hospital, Austin, Texas, for Clinical Training for Nursing Students. --

Chancellor LeMaistre concurs in the request of Vice-Chancellor Knisely and Dean Willman that an affiliation agreement with Brackenridge Hospital, Austin, be ratified and that the Chairman be authorized to execute the agreement.

This agreement conforms to the model agreement approved by the Board on September 12, 1970 and has been approved both as to form and content by appropriate administrative officials.

5. System Nursing School: Affiliation Agreement with Schlesinger's Home Health Service Agency, Austin, Texas, for Clinical Training for Nursing Students. --

Chancellor LeMaistre concurs in the request of Vice-Chancellor Knisely and Dean Willman that an affiliation agreement with Schlesinger's Home Health Service Agency, Austin, be ratified and that the Chairman be authorized to execute the agreement.

This agreement conforms to the model agreement approved by the Board on September 12, 1970, and has been approved both as to form and content by appropriate administrative officials.

III. ITEMS FOR THE RECORD. --Below are items that have been approved by the Committee of the Whole and are reported for the record and for ratification:

A. U. T. Austin

6. Development Board Membership.--On June 4, 1971, nominations of those individuals starred (*) in the list below were approved for membership on the Development Board of The University of Texas at Austin. Their acceptances have been received, and the complete membership of the U. T. Austin Development Board follows:

	<u>Term Expires</u>
Mr. Rex G. Baker, Jr.*, Houston, Texas	1974
Senator Lloyd M. Bentsen, Jr.*, Washington, D.C.	1974
Mr. Ernest Cockrell, Jr., Houston, Texas	1973
Mr. H.H. Coffield*, Rockdale, Texas	1974
Mr. L.L. Colbert*, Detroit, Michigan	1974
Mr. Marvin K. Collie*, Houston, Texas	1973
Mr. C.W. Cook*, White Plains, New York	1974
Mr. B.W. Crain, Jr.*, Longview, Texas	1974
Mr. Joe M. Dealey*, Dallas, Texas	1974
Mr. Franklin W. Denius, Austin, Texas	1973
Mr. Walter W. Fondren III, Houston, Texas	1973
Mr. Hayden W. Head*, Corpus Christi, Texas	1974
Mr. Dan M. Krausse, Dallas, Texas	1973
Mr. Wales H. Madden, Jr.*, Amarillo, Texas	1974
Mrs. Eugene McDermott, Dallas, Texas	1972
Mr. J. Mark McLaughlin, San Angelo, Texas	1972
Mr. J.M. Odom, Austin, Texas	1974
Mr. B.D. Orgain, Beaumont, Texas	1972
Mr. Preston Shirley, Galveston, Texas	1973
Mr. Jack G. Taylor, Houston, Texas	1973
Mr. John P. Thompson, Dallas, Texas	1972
Mr. Dan C. Williams, Dallas, Texas	(Regent Representative)
Mr. J.D. Wrather, Jr., Beverly Hills, California	1973

B. M. D. Anderson

7. Approval of Offer of Board of Visitors' Campaign for Expansion and Development. --Following a discussion of the Conquest of Cancer Bill pending in Congress, and a proposal of the Board of Visitors of the University Cancer Foundation by Mr. Leroy Jeffers, the Committee of the Whole on July 30, 1971, accepted with sincere appreciation the generous offer of the Board of Visitors to assume the responsibility for raising funds in the amount of \$15,000,000 needed in the expansion and physical development of M. D. Anderson. Approval was also given to the Board of Visitors' plan for raising this money which is not to be a general campaign but is to be directed to selected foundations, selected individuals, and selected corporations. (It will particularly include persons who either themselves or family members have developed close ties with M. D. Anderson by reason of some member of the family having had a patient there.)

IV. SCHEDULED MEETINGS AND EVENTS. --The following meetings of the Board of Regents have been scheduled:

October 22, 1971 - in Austin
December 3, 1971 - in Austin

Below are other events in addition thereto in which the Regents may be interested:

1971

S M T W T F S							S M T W T F S							
SEP.				1	2	3	4	NOV.	1	2	3	4	5	6
	5	6	7	8	9	10	11		7	8	9	10	11	12
	12	13	14	15	16	17	18		14	15	16	17	18	19
	19	20	21	22	23	24	25		21	22	23	24	25	26
	26	27	28	29	30				28	29	30			
OCT.					1	2		DEC.		1	2	3	4	
	3	4	5	6	7	8	9		5	6	7	8	9	10
	10	11	12	13	14	15	16		12	13	14	15	16	17
	17	18	19	20	21	22	23		19	20	21	22	23	24
	24	25	26	27	28	29	30		26	27	28	29	30	31
	31													

1972

S M T W T F S							S M T W T F S							
JAN.						1	JULY	2	3	4	5	6	7	8
	2	3	4	5	6	7		9	10	11	12	13	14	
	9	10	11	12	13	14		16	17	18	19	20	21	
	16	17	18	19	20	21		23	24	25	26	27	28	
	23	24	25	26	27	28		30	31					
	30	31												
FEB.			1	2	3	4	AUG.		1	2	3	4	5	
	6	7	8	9	10	11		6	7	8	9	10	11	
	13	14	15	16	17	18		13	14	15	16	17	18	
	20	21	22	23	24	25		20	21	22	23	24	25	
	27	28	29					27	28	29	30	31		
MAR.				1	2	3	SEP.				1	2		
	5	6	7	8	9	10		3	4	5	6	7	8	
	12	13	14	15	16	17		10	11	12	13	14	15	
	19	20	21	22	23	24		17	18	19	20	21	22	
	26	27	28	29	30	31		24	25	26	27	28	29	
APR.						1	OCT.	1	2	3	4	5	6	7
	2	3	4	5	6	7		8	9	10	11	12	13	
	9	10	11	12	13	14		15	16	17	18	19	20	
	16	17	18	19	20	21		22	23	24	25	26	27	
	23	24	25	26	27	28		29	30	31				
	30													
MAY			1	2	3	4	NOV.			1	2	3	4	
	7	8	9	10	11	12		5	6	7	8	9	10	
	14	15	16	17	18	19		12	13	14	15	16	17	
	21	22	23	24	25	26		19	20	21	22	23	24	
	28	29	30	31				26	27	28	29	30		
JUNE				1	2	3	DEC.				1	2		
	4	5	6	7	8	9		3	4	5	6	7	8	
	11	12	13	14	15	16		10	11	12	13	14	15	
	18	19	20	21	22	23		17	18	19	20	21	22	
	25	26	27	28	29	30		24	25	26	27	28	29	
								31						

1971

- Oct. 22 Board of Regents' Meeting in Austin
- Oct. 22 Ex-Students' Distinguished Alumni Banquet
- Nov. 12 Longhorn Hall of Honor in Austin
- Nov. 12 Dedication of Libbie Moody Thompson Basic Sciences Building in Galveston
- Dec. 3 Board of Regents' Meeting in Austin

Fall 1971

- Sept. 18 Austin vs. U. C. L. A. at Los Angeles
- Sept. 25 Austin vs. Texas Tech at Austin
- Oct. 2 Austin vs. Oregon at Austin
- Oct. 9 Austin vs. Oklahoma at Dallas
- Oct. 16 Austin vs. Arkansas at Little Rock
- Oct. 23 Austin vs. Rice at Austin
- Oct. 30 Austin vs. S. M. U. at Dallas
- Nov. 6 Austin vs. Baylor at Austin
- Nov. 13 Austin vs. T. C. U. at Austin
- Nov. 25 Austin vs. Texas A&M at College Station
- Nov. 25 Thanksgiving
- Dec. 24-29 Christmas holidays

COMMITTEE OF THE WHOLE
EXECUTIVE SESSION

Emergency Items
September 8, 1971

7. U. T. System: Discussion of Personnel and Legal Matters Relating to Wage-Price Freeze 18
8. U. T. El Paso: Legal Matters Relating to the Acceptance of a Grant from the United States Office of Education 18

7. U. T. System: Wage-Price Freeze - - The following resolution was presented by System Administration:

WHEREAS, the President of the United States issued an Executive Order providing for stabilization of prices, rents, wages and salaries for a period of 90 days beginning on August 15, 1971:

BE IT RESOLVED, that The University of Texas System and all of its component institutions will comply fully with the guidelines concerning the price and wage controls established by the Office of the President, and

BE IT FURTHER RESOLVED, that except for modifications required by the applications of the foregoing guidelines, all heretofore approved 1971-72 operating budgets for The University of Texas System and its component institutions remain in full force and effect.

8. U. T. El Paso: Legal Matters Relating to the Acceptance of a Grant from the United States Office of Education. --Below is the documentation presented by Chancellor LeMaistre:

MEMORANDUM

TO: Members of the Board of Regents

Mr. Peace, Chairman
Mr. Ikard, Vice-Chairman
Mr. Erwin
Mr. Garrett
Mrs. Johnson
Mr. Kilgore
Mr. McNeese
Dr. Nelson
Mr. Williams

FROM: Charles A. LeMaistre, M.D. *cel*
Chancellor

SUBJECT: Background and Recommendation concerning Grant for Tutoring Program and Related Research at U.T. El Paso

This information relates to the emergency agenda item, "U.T. El Paso: Legal Matters Relating to the Acceptance of a Grant from the United States Office of Education by The University of Texas at El Paso." I am sending this to you in advance of the meeting to permit you more time to consider it.

U.T. El Paso submitted a grant proposal to the U.S. Office of Education in March 1971 entitled, "The University of Texas at El Paso Special Services Program for Disadvantaged Chicano Students." On April 21 and later on July 16 the System Administration informed Dr. Smiley that the grant was in conflict with the Rules and Regulations and Regents' policies on the four major points listed below:

1. It was discriminatory in offering tutorial assistance preferentially to only Mexican-American students.
2. It proposed the recruitment of unqualified students.

Memorandum to the Board of Regents
Page 2
September 2, 1971

3. It proposed extending the Provisional Admission Program to admit students in the fall semester.
4. It proposed extending the trial period for provisionally admitted students from one semester or two summer terms to two semesters.

In the exchange of correspondence on this proposal, we also pointed out that the proposal had two other deficiencies as follows:

1. It focused upon the unqualified student when our first concern should be with determining what needs to be done in the educational program to reduce the attrition rate among qualified students who were prepared to enter college but who drop out in large numbers.
2. A program of tutoring alone would not provide us with useful information about our educational processes. It was suggested that if U.T. El Paso were planning to pursue the project further, a research component be added to identify the deficiencies in our educational process which do not bring to full fruition the intellectual capacities of students or fail to maximize student motivation.

Dr. Smiley chose not to seek waivers from the Board of Regents of your rules and policies. He has instead negotiated a complete modification in the proposed project with USOE to bring it into conformity with your rules and policies. The project is now to be entitled, "The University of Texas at El Paso Special Services Program for Student Assistance." Based on the agreements Dr. Smiley has reached with USOE, he is now prepared to develop an operating plan to carry out the program. Under the modified project, there will be no recruitment of unqualified students, and the services of the program will be open to students on a nondiscriminatory basis. The proposed extension of the Provisional Admission Program to the fall has been deleted, and the lengthening of the trial period for provisionally admitted students has been removed.

In addition, the "target group" extends beyond the provisionally admitted unqualified student to include qualified students who

Memorandum to the Board of Regents
Page 3
September 2, 1971

have marginal scores on the SAT and those qualified students who perform marginally after admission.

The one area in which USOE cannot accept Dr. Smiley's proposed modification relates to the funding of the research component of the program. The branch of USOE funding this proposal cannot support research projects. Therefore, Dr. Smiley would propose to allocate \$12,000 from trust funds to finance the research aspects of the total program.

In view of the historical development of this project, the inability to obtain funds for the research aspects of the project, and the fact that a grant of \$130,000 has now been offered to U.T. El Paso, Dr. Smiley has requested further guidance from the U.T. System Administration and Regents before he proceeds any further with negotiations with the Federal Government.

This subject is brought to the Board to determine whether the steps that have been taken have Board concurrence.

I recommend that the Board authorize the U.T. System and U.T. El Paso to complete negotiations with the Office of Education and to develop a detailed operating plan in accordance with the modifications Dr. Smiley has worked out for submission to the Board of Regents on October 22. The operating plan must comply with the following points and conditions:

1. It will conform to the Regents' Rules and Regulations.
2. The program will be under the complete control of the U.T. El Paso Administration, including budgetary control and the appointment of the project director and the professional staff by the President.
3. There will be six- and nine-month reports filed with the System Administration.
4. The project will be a one-year program, from the date of Regental approval, the results of which will be reported to the U.T. System Administration and the Board of Regents prior to any consideration of continued funding.

Memorandum to the Board of Regents
Page 4
September 2, 1971

5. There will be no amendments or modifications in the program without prior approval.
6. In view of the possibility that federal funds may not be available to continue the project, no long-term commitments are to be made or implied to any new staff.

These conditions have been discussed with Dr. Smiley and are acceptable to him. I apologize for the late submission of this item to you, but Dr. Smiley's August 30 letter describing the negotiations on the project and his request for further guidance has just been received.

nn

cc: Miss Betty Anne Thedford
Mr. E. D. Walker
Dr. Kenneth H. Ashworth
Dr. J. R. Smiley

COMMITTEE OF THE WHOLE

EXECUTIVE SESSION

September 8, 1971

The items listed on the Agenda of the Executive Session of the Committee of the Whole relate either to personnel matters, land acquisition, and security or to items requiring legal consultation.

BOARD OF REGENTS OF THE UNIVERSITY OF TEXAS SYSTEM
September 8, 1971

STRICTLY
EXECUTIVE SESSION

	<u>Page No.</u>
1. U. T. System: Legal Matters Relating to Marine Biomedical Institute	2
2. U. T. Austin: Legal Considerations Concerning Agreement with Travis County Legal Aid and Defender Society	9
2a. U. T. Austin: Legal Aspects Relating to Student Publications	14
3. Dallas Medical School: Waiver of <u>Rules and Regulations</u> Regarding Retirement	14
4. Houston Medical School: Waiver of <u>Rules and Regulations</u> Regarding Nepotism	15
5. System Nursing School: Nomination to Advisory Council of School of Nursing (System-wide) Foundation	16
6. Legal Aspects of Future Foundation Grants and Operation (by Chancellor Emeritus Ransom)	16

1. U. T. System: Legal Matters Relating to the Marine Biomedical Institute. -- (Pages 2-8)

Chancellor LeMaistre concurs in the following recommendations of the U.T. System Advisory Council on Marine-Related Affairs as communicated to him by the Chairman of the Council, Vice-Chancellor Ashworth:

1. That the following Memorandum of Understanding be approved by the Board of Regents and substituted for the Memorandum of Understanding executed between President Blocker and Texas A&M University President, Earl Rudder, on October 11, 1968 (copy also attached), concerning the Marine Biomedical Institute.
2. That the Chancellor be authorized and directed to send as soon as possible this new Memorandum of Understanding with an invitation to affiliate with the Marine Biomedical Institute to the presidents of U.T. Austin and U.T. Dallas and to the deans of the U.T. San Antonio Medical School and the U.T. Southwestern Medical School at Dallas, and to such other institutions of higher education and research agencies and State agencies as express an interest in affiliating with the Marine Biomedical Institute as outlined in the Memorandum of Understanding.
3. That the Chancellor be authorized and directed specifically to offer the new Memorandum of Understanding to Texas A&M University as a substitute for the October 11, 1968 Memorandum of Understanding executed with Texas A&M University.
4. That the seal presently used by the Marine Biomedical Institute be abolished and that President Blocker be requested to submit a new seal for adoption by the Board of Regents. (Copy of existing seal adopted by the Regents on June 20, 1969 is attached.)

These actions are recommended to provide a mechanism for obtaining greater and more efficient utilization of those marine-related resources, facilities, and equipment now existing and to exist in the future at the U.T. Medical Branch at Galveston. With the increasing importance of marine-related affairs to the people of Texas and our students and with the need to maximize the inter-institutional use of specialized and expensive facilities, it is desirable to open the Marine Biomedical Institute to equal participation by all of the U.T. System institutions and by other universities and colleges in the State and region, both public and private. It is also desirable that the resources available at the Marine Biomedical Institute be made available to State agencies and research agencies. The existing agreement limits participation in the Marine Biomedical Institute and does not provide equal representation for all U.T. System institutions or other institutions of higher education and agencies. Other institutions have expressed an interest in participating in the Marine Biomedical Institute, but they wish to have equal representation on the Coordinating Committee along with other participating

institutions. The new Memorandum of Understanding corrects those deficiencies in the Memorandum of Understanding executed October 11, 1968 between the University of Texas Medical Branch at Galveston and Texas A&M University.

The previously adopted seal contains the names of the U.T. Medical Branch at Galveston and Texas A&M University and should be modified to be consistent with the new arrangements under the proposed new Memorandum of Understanding.

MEMORANDUM OF UNDERSTANDING
CONCERNING PARTICIPATION OF INSTITUTIONS
OF HIGHER EDUCATION AND RESEARCH AGENCIES
AND STATE AGENCIES WITH
THE UNIVERSITY OF TEXAS MEDICAL BRANCH
IN THE MARINE BIOMEDICAL INSTITUTE AT GALVESTON

It is agreed that:

- (1) The University of Texas Medical Branch at Galveston together with other institutions of higher education will work together through the Marine Biomedical Institute to advance the understanding of biomedical sciences research and education associated with the marine environment.
- (2) The Marine Biomedical Institute ^{be} is located at Galveston with administrative offices and a main facility on the campus of The University of Texas Medical Branch. Other specialized facilities under the jurisdiction of the Institute may be located off campus as experience requires. The name of the Institute ^{be} is "The Marine Biomedical Institute."
- (3) The Institute ^{be} is administered and budgeted through The University of Texas Medical Branch and the Director of the Institute. The Director of the Marine Biomedical Institute may initiate grant proposals through the President of The University of Texas Medical Branch to any institution or government agency or private donor and may receive support directly from such institutions, agencies, or donors. In some instances, he will be responsible for maintaining adequate administrative procedures to satisfy the specific granting institution or agency and the Rules and Regulations of The University of Texas System Board of Regents. Where proposals require commitments from any institution of higher education or agency affiliated with the Marine Biomedical Institute, prior approval will have been obtained from the appropriate institution or agency.
- (4) A Coordinating Committee ^{be} is established and shall initially consist of representatives of the following institutions upon their acceptance of this Memorandum of Understanding: The University of Texas Medical Branch at Galveston, The University of Texas at Austin, The University of Texas at Dallas, The University of Texas Medical School

at San Antonio, The University of Texas Southwestern Medical School at Dallas, and Texas A&M University. The Director of the Marine Science Institute at Port Aransas and the Marine Biomedical Institute shall also be members of the Coordinating Committee. Each additional institution of higher education or agency that affiliates under this Memorandum of Understanding shall have one representative on the Coordinating Committee. The University of Texas Medical Branch representative shall be the President of that institution, and he will be permanent chairman of the Coordinating Committee. All members of the Coordinating Committee, with the exception of the Director of the Marine Biomedical Institute, who shall be Executive Secretary to the Coordinating Committee, will have a vote and the Chairman may vote in the event of a tie. The Vice-Chairman shall be elected annually from among the member representatives at that time. Those institutions of higher education and agencies which affiliate under this Memorandum of Understanding shall follow their own procedures for designating representatives to serve on the Coordinating Committee. The Coordinating Committee's role will be advisory to the Marine Biomedical Institute. In this capacity, it will provide advice on matters of policy and procedures of the participating institutions and agencies. The Coordinating Committee will provide the Director of the Marine Biomedical Institute with advice on the content of the Institute's research program, the quality of the Institute's staff, and other matters relating to the program of the Institute and its funding. The Committee will make an annual report of the Institute's programs, progress, accomplishments, and problems, including finances and facility, to the participating institutions and agencies.

- J. H. ...*
- (5) The President of The University of Texas Medical Branch, after consultation with the Coordinating Committee, will recommend the Director of the Institute for approval by the Chancellor of The University of Texas System, subject to the Rules and Regulations of the University of Texas Board of Regents.
 - (6) The Marine Biomedical Institute will conduct as much of its program as is feasible with staff members from the respective institutions after appropriate inter-institutional or inter-agency agreements are reached. Adjunct appointments may be made as appropriate among participating institutions. These agreements are required

when significant resources or fiscal commitments are involved. The President of The University of Texas Medical Branch will submit any such agreements to the institutions or agencies annually or as required for concurrence prior to submitting them to The University of Texas System for final approval.

- (7) The Marine Biomedical Institute will invite and provide the opportunity for other institutions of higher learning, research agencies, or State agencies to participate with The University of Texas Medical Branch in the program of the Institute.
- (8) Implicit in this understanding is the necessity for each institution to control its material, equipment, and related items. Material, equipment, and related items obtained through joint projects of participating institutions funded from outside sources and applied for through the Institute will remain the property of the Institute where appropriate. In any case, administrative control of all such property will remain with the Institute.
- (9) Upon written notification to the President of The University of Texas Medical Branch, any participating institution may terminate its affiliation under this Memorandum of Understanding.

APPROVED:

 T. G. Blocker, Jr., M.D.
 President
 The University of Texas Medical Branch

_____ Date

APPROVED BY PARTICIPATING INSTITUTIONS AND AGENCIES:

Chief Administrative Officer	Date of Affiliation
_____	_____
_____	_____
_____	_____
_____	_____

MEMORANDUM OF UNDERSTANDING
CONCERNING THE JOINT PARTICIPATION BY
TEXAS A&M UNIVERSITY AND THE UNIVERSITY OF TEXAS MEDICAL BRANCH
IN A MARINE BIOMEDICAL PROGRAM AT GALVESTON

October 11, 1968

It is mutually agreed that:

1. The University of Texas Medical Branch at Galveston and Texas A&M University will work together to advance the understanding of the biomedical sciences through research and education associated with the marine environment.
2. The University of Texas Board of Regents and Texas A&M University Board of Directors have established a marine biomedical institute at Galveston with administrative offices and main facility located on the campus of The University of Texas Medical Branch. Other specialized facilities under the jurisdiction of the institute may be located off campus as expedience requires.

The name of the institute is "THE MARINE BIOMEDICAL INSTITUTE JOINTLY SPONSORED BY THE UNIVERSITY OF TEXAS MEDICAL BRANCH AND TEXAS A&M UNIVERSITY."

3. This proposal is limited to The Marine Biomedical Institute at Galveston and does not affect existing agreements between The University of Texas System and Texas A&M University (e.g., water resources) nor preclude additional agreements.
4. The Institute is to be administered, including budgetary considerations, by The University of Texas Medical Branch through the Director of the Institute. The Director of The Marine Biomedical Institute may initiate grant proposals through the President of The University of Texas Medical Branch to any institution and may receive support directly from such institutions. In such instances, he will be responsible for maintaining adequate administrative procedures to satisfy the specific granting institution, within the Rules and Regulations of the Board of Regents. Where grant proposals require commitments from Texas A&M University, prior approval will have been obtained from the appropriate Texas A&M official.
5. The President of The University of Texas Medical Branch, in consultation with Texas A&M University, will nominate the Director of the Institute for approval by the Chancellor of The University of Texas System, subject to the Rules and Regulations of the Board of Regents.

6. A Coordinating Committee will be established and consist of a total of seven people: three from The University of Texas System, one of whom will be the President of The University of Texas Medical Branch; three from Texas A&M University, one of whom will be the Vice-President for Research, Texas A&M University; and an Executive Secretary, who will also be the Director of the Institute. The President of The University of Texas Medical Branch will be the permanent Chairman of the Coordinating Committee, and the Vice President for Research of Texas A&M University will be the permanent Vice Chairman of the Coordinating Committee. The Coordinating Committee's role will be advisory to The Marine Biomedical Institute. In this capacity, it will provide advice on matters of policy and procedures of the respective sponsoring institutions. The Coordinating Committee will provide the Director of The Marine Biomedical Institute with advice on the content of the Institute's research program, the quality of the Institute's staff, and other matters relating to the program of the Institute and its funding. The Committee will make an annual report of the Institute's programs, progress, accomplishments, and problems, including finances and facilities, to their respective universities.
7. The Marine Biomedical Institute will conduct as much of its program as is feasible with staff members from the respective institutions after appropriate inter-institutional agreements are reached. These agreements are required when significant resources or fiscal commitments are involved. The President of The University of Texas Medical Branch will submit the program to Texas A&M University annually or as required for concurrence prior to submitting it to The University of Texas System for final approval.
8. The Marine Biomedical Institute will provide the opportunity for other research agencies, universities, and colleges to participate with The University of Texas Medical Branch and Texas A&M University in the program of the Institute.
9. Implicit in this understanding is the necessity for each institution to control its material, equipment, and related items. Material, equipment, and related items obtained through joint projects of the participating institutions funded from outside sources and applied for through the Institute will remain the property of the Institute where appropriate. In any case, administrative control of all such property will remain with the Institute.

APPROVED:

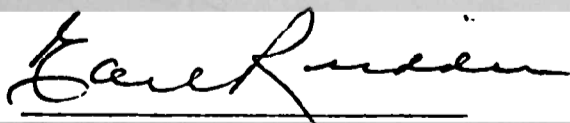

Earl Rudder
President
TEXAS A&M UNIVERSITY

APPROVED:

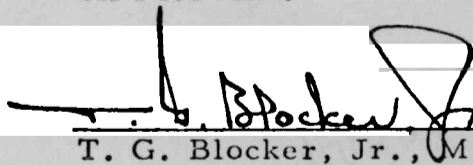

T. G. Blocker, Jr., M.D.
President
THE UNIVERSITY OF TEXAS
MEDICAL BRANCH



Refer

2. U. T. Austin: Legal Considerations Concerning Agreement with Travis County Legal Aid and Defender Society. --

Chancellor LeMaistre submits President Spurr's recommendation regarding relationships between U.T. Austin and the Travis County Legal Aid and Defender Society and the related Memorandum Agreement* for information to the Board of Regents.

Chancellor LeMaistre is reviewing this matter further and will present his recommendations to the Board at the time of the meeting. In any event, if the Agreement is to be approved, Section III should be amended to require, in accordance with standard business practices, that invoices be approved by the Vice-President for Business Affairs as well as the Dean of the Law School.

President

August 6, 1971

Charles A. LeMaistre, M. D.
Chancellor
The University of Texas System
O. Henry Hall
601 Colorado Street

Dear Chancellor LeMaistre:

Enclosed is a memorandum agreement between the University and Travis County Legal Aid and Defender Society which I recommend for approval.

The proposed agreement will provide a mechanism for students in the Law School to receive desirable clinical experience as part of their education. In return for the services which the Travis County Legal Aid and Defender Society (LADS) would render to the Law School by providing the facility, the University under the terms of the agreement would agree to pay a sum not to exceed \$18,000 per year, with specific invoices being submitted by LADS to the Dean of the Law School. The cost does not seem unreasonable, and funds are available in the Legal Aid Clinic budget of the Law School.

Sincerely yours,

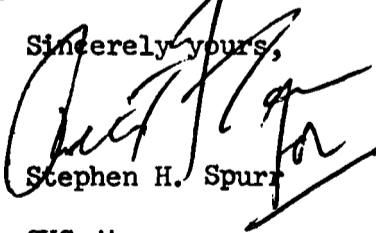

Stephen H. Spurr

SHS:jt

Enclosure

cc: Vice President Peter Flawn
Dean Page Keeton

* Memorandum Agreement set out on next two pages.

CHANCELLOR'S OFFICE U. T. T.

Acknowledged..... File.....

REC'D AUG 11 1971

To.....For Info and Return
To..... Please Advise Me
To..... Please Handle

THE STATE OF TEXAS I
COUNTY OF TRAVIS I

THIS MEMORANDUM AGREEMENT by and between the Board of Regents of The University of Texas System, for and on behalf of the University of Texas at Austin School of Law, hereinafter called University and Travis County Legal Aid and Defender Society, herein called LADS,

WITNESSETH:

WHEREAS, University recognizes that a law school of the first class should offer its students opportunities to obtain first-hand experience in handling legal problems of the public and

WHEREAS, LADS represents that it can provide these services;

NOW, THEREFORE, for and in consideration of the mutual benefits and the covenants herein contained, the parties agree as follows:

I.

LADS agree to furnish all services as may be required from time to time by the University for the purpose of providing clinical legal education and to perform such duties incidental to the clinical legal education program as are required for conforming to the policies and rules of the University. It is recognized that a good law school through the utilization of faculty and interested students must confront the problem of the poor and assist in bringing them into the world of the law and lawyers. It is universally recognized that such a program provides a laboratory for students in the law school for the development of practice skills. Of almost equal importance is the opportunity to contribute toward achieving the ancient and honored goal of the legal profession of equal justice for the poor. LADS, therefore, agrees to render such services as required by the University so that these functions can be adequately performed.

II.

It is understood and agreed that LADS will conduct its programs and integrate its work in such a manner as to furnish the means by which legal education can be advanced and students better prepared

for the practice of law, all of which is in the public interest and an essential part of the law school function.

III.

University agrees to pay LADS for the services to be rendered a sum not to exceed \$18,000 per year, which sum of money is to be paid to LADS upon invoices submitted to University which shall be approved by the Dean of The University of Texas School of Law. It is contemplated that such invoices shall be for services rendered--legal and secretarial--and invoices will be submitted, normally on a monthly basis, by LADS to the Dean of The University of Texas School of Law.

IV.

This agreement shall become effective immediately upon its execution and shall remain in effect from year to year thereafter unless modified in writing by the mutual agreement of the parties hereto or terminated by either party upon giving ninety (90) days' written notice to the other party.

EXECUTED THIS _____ day of _____, 1971.

Attest:

BOARD OF REGENTS OF THE
UNIVERSITY OF TEXAS SYSTEM

Secretary

By: _____
Chairman

Attest:

TRAVIS COUNTY LEGAL AID AND
DEFENDER SOCIETY

By: *Hume Lopez*

Approved as to form:

Approved as to content:

University Attorney

Vice-Chancellor for Academic Affairs

James L. Allen
Vice-President for Business Affairs

August 17, 1971

Memorandum

To: Dr. Stephen Spurr, President
From: Page Keeton, Dean *wBK*
Re: Proposed Contract With Travis County Legal Aid and Defender Society

This memorandum is for the purpose of answering several questions that might be raised in connection with the proposal which we have made to enter into a contract with the Travis County Legal Aid and Defender Society for the purpose of providing clinical legal education for our students.

1. Some may wish to know what experience our students will receive and what kind of supervision they will have. Until recently the law schools of this country had not succeeded in providing graduates with any kind of clinical legal education such as that provided for doctors and secondary school teachers for years. However, after some discussion at this law school and others regarding various ways to improve the quality of education, we last year established a legal services office in East Austin. While providing legal services to the indigent, the program provides the law students with clinical experiences. An additional by-product of the program is the empirical data and "live" cases provided to the faculty to enrich the classroom lectures. The purpose of this contract is to improve the clinical experiences that we have been providing by way of effecting a joint operation with the Travis County Legal Aid and Defender Society.

The supervision of students in the program is the responsibility of ten staff attorneys. As a result of merging with the LADS program, we have been able to double the size of the staff and reduce the student-attorney ratio so that it is one staff to six students, which is well within the national maximum standard of one to ten.

During the law student's first semester in the program he will be assigned to the Family and Health Law section and will be under the supervision of three full-time staff attorneys. The students interview clients with supervision, draft pleadings which are approved and signed by the attorneys, and appear in court and question the witnesses (with supervising attorney present at all times). In conjunction with the office duties the students will attend a seminar in which detailed instruction will be given in family and health problems. A comprehensive Family Law manual is used in this seminar, which is conducted by members of the LADS staff and a full-time professor of the Law School.

During the second semester the student is assigned to one of the following five sections: Housing Law, Consumer Law, Welfare Law, and Litigation. Each section conducts seminars in its respective field throughout the semester.

The clinical aspect of the program is supervised by two members of the Law School faculty. One professor has overall supervision of the total program and reports directly to the Dean of the Law School. An instructor spends full time in the LADS offices, with overall administrative supervision of students and staff.

Were it not for the merger, certainly the students could not benefit from specialization and close supervision.

2. The question has been raised as to whether or not the lawyers of Travis County are likely to approve the action that is being taken. The Travis County Legal Aid and Defender Society was created as a separate corporation by action of the Travis County Bar Association. The proposal to merge our operations with those of the Travis County Legal Aid and Defender Society was initiated by them. The proposed contract was signed by the president of the Travis County Legal Aid and Defender Society and thereafter approved by action of the Board of Directors of the Travis County Bar Association in June of this year without a dissenting vote. It therefore can be said without qualification that the proposal has the endorsement of the lawyers of Travis County as a whole. Some of the lawyers who have been most active in this are: W. W. Patterson, Robert Jones, Bill Hilgers, Tom Gee and Hume Cofer.

3. What is the source for the \$18,000 which is the sum set forth in the contract that the University will make available to the Travis County Legal Aid and Defender Society? The total budget approved by the Regents at their last regular meeting for the Legal Aid Clinic was \$25,735.00 for the fiscal year of 1971-72. This was approximately \$2,000 more than last year. To this must be added \$7,000 for a part-time instructor's salary in our teaching budget, the same as last year. Thus, the Regents approved a total amount of \$32,735.00 for our Legal Services Program. Of this amount, it is proposed that we retain on our payroll a full-time person, namely John Scanlan, who will draw a salary of \$14,500. This leaves a balance of \$18,235. The contract provides for \$18,000. Thus, the total amount proposed for utilization is \$235.00 less than that which the Regents actually approved. We do not propose to turn this \$18,000 over to the Travis County Legal Aid and Defender Society. Rather, we will have them draw on it at the rate of \$1,500 monthly, showing the purposes for which the money will be spent. It will be spent largely on salaries for another lawyer and for a secretary.

4. The question has been raised as to whether or not this is being done primarily to bail out and to help the Travis County Legal Aid and Defender Society or to serve our objectives. Both the Law School and the Travis County Legal Aid and Defender Society were having financial difficulties. By having two separate operations, it is obvious that certain expenses were being duplicated by way of providing legal services to those who cannot afford to pay. Over the last few years we have been able to induce various foundations to supplement the funds expended from appropriations and from our Law School budget. We have obtained temporary grants from the Moody Foundation, Hogg Foundation and Ford Foundation, all to support this program as an experiment in clinical education. These temporary grants were in the nature of "seed" money and were calculated to disappear. The Travis County Legal Aid and Defender Society received substantial funds from several sources but this too was inadequate for their objectives. They were obviously in need of a large number of students to help with their program. The joint operation will help the Travis County Legal Aid and Defender Society and it will help us. We think it will improve the services rendered to the indigent and that it will also improve the clinical experiences of our students.

5. What will the joint action do to our relations with people in the community? In my judgment, the joint action will have the effect of eliminating one of the sources of irritation that we now have. Necessarily, certain law suits instituted on behalf of the poor, especially in connection with public housing, urban renewal, landlord and tenant and the like, are almost always controversial. It is better if we can provide our students with good clinical experiences through agencies other than The University of Texas if possible. I am, therefore, quite pleased about the prospects of having a joint operation.

2a. U. T. Austin: Legal Aspects Relating to Student Publications. --

3. Dallas Medical School: Waiver of Rules and Regulations Regarding Retirement. --

Chancellor Charles A. LeMaistre concurs in the recommendation of Dean Charles C. Sprague that Mervyn B. Starnes, D.V.M., Director of Animal Hospital and Associate Professor of Microbiology, be allowed to remain in his administrative position for the 1971-72 fiscal year even though he has reached the mandatory retirement age of 65.

Authorization for this exception from the mandatory retirement age is contained in the Rules and Regulations, Part I, Chapter 3, paragraph 31.(17).

Dean Sprague's justification for this request is set forth in the letter which follows.

August 15, 1971

CHANCELLOR'S OFFICE
Acknowledged _____ File _____

REC'D AUG 17 1971

To _____ For Info and Return
To _____ Please Advise Me
To _____ Please Handle

Dr. Charles A. LeMaistre
Chancellor
The University of Texas System
601 Colorado Street
Austin, Texas 78701

Dear Dr. LeMaistre:

Approval is requested to continue the employment of Mervyn B. Starnes, DVM, Director of Animal Hospital and Associate Professor of Microbiology, in his administrative position for the 1971-72 fiscal year. Dr. Starnes has reached the mandatory retirement age of 65 and is required to retire from his administrative position unless an exception is granted under the Regents Regulations.

We did not submit this request with our budget submission since it was anticipated that we would find a qualified replacement for Dr. Starnes prior to September 1, 1971. There is now a probability that a replacement will not be available for several months; and we cannot provide adequate management of the animal facilities in the interim without an individual with the professional training and experience possessed by Dr. Starnes.

Your approval of this request will be appreciated.

Sincerely,

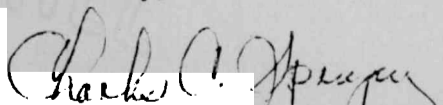
Charles C. Sprague, M. D.
Dean

CCS:mc

Approved
cal

a.c.

OFFICE OF THE BOARD OF REGENTS

MEMORANDUM

DATE August 31, 1971

TO: Chairman John Peace

FROM: Betty Anne Thedford

SUBJECT: COMMENT WITH RESPECT TO ITEM 4, AGENDA OF THE EXECUTIVE SESSION, C OF W - BLUE SHEETS, PAGE 15

With respect to Item 4, Page 15 of the Executive Session of the Committee of the Whole, I direct your attention to a similar item that was discussed in Executive Session at the April meeting. A copy of that minute order is attached, and you will observe that the waiver of the rule was for a period of two years only.

T:njp
Attachment

HOUSTON MEDICAL SCHOOL: WAIVER OF REGENTS' RULES AND REGULATIONS, PART ONE (CHAPTER III, SECTION 5.42) TO PERMIT THE EMPLOYMENT OF DR. EMIL STEINBERGER AND DR. ANNA STEINBERGER. --Upon recommendation of Dean Smythe, concurred in by Chancellor LeMaistre, Section 5.42, Chapter III, Regents' Rules and Regulations, Part One, was waived to permit the employment of Dr. Anna Steinberger as Associate Professor of Reproductive Biology at The University of Texas Medical School at Houston for a period of two years. Dr. Emil Steinberger, husband of Dr. Anna Steinberger, has been appointed as Professor of Reproductive Biology and Reproductive Endocrinology effective May 1, 1971.

April
23, 1971
Meeting

4. Houston Medical School: Waiver of Nepotism Rule to Allow Employment of Dr. Eugene Jacobson and Dr. Linda Jacobsen. --

Chancellor LeMaistre concurs in the request of Dean Smythe that the nepotism rule be waived in accordance with the authority contained in the Rules and Regulations, Part One, Chapter III, Section 5.42 to allow the employment of Dr. Eugene Jacobson and Dr. Linda Jacobson.

August 11, 1971

Office of the Dean
713/526-8431

CHANCELLOR'S OFFICE U. of T.

Acknowledged..... File.....

REC'D AUG 12 1971

To..... For Info and Return
To..... Please Advise Me
To..... Please Handle

Dr. Charles A. LeMaistre
Chancellor
The University of Texas System
P. O. Drawer 7969
Austin, Texas 78712

Dear Dr. LeMaistre:

On April 16, 1971, Dr. Eugene Jacobson was appointed Professor of Physiology of The University of Texas Medical School at Houston. At the same time Dr. Linda Shanbour was appointed Associate Professor of Physiology. Dr. Jacobson and Dr. Shanbour had been professional colleagues at the University of Oklahoma Medical Center. When they were recruited to this School, Dr. Jacobson informed me of their intention to marry in early July.

In as much as Drs. Jacobson and Shanbour are now husband and wife and working in the same unit with Mrs. Jacobson reporting to her husband, we are requesting that Section 5 of Chapter III of Part I of the Rules and Regulations of the Board of Regents (nepotism rule) be waived.

Attached to this letter are copies of the curricula vitae of both Dr. Jacobson and Dr. Shanbour. She had established her reputation as a productive independent scientist prior to joining Dr. Jacobson three years ago. In the past three years she has published 34 papers, some in conjunction with Dr. Jacobson and some independently. Her research productivity has increased. In addition, at Oklahoma she has taught in the medical school, sponsored graduate students and conducted an active research program. She is independently granted and has just been awarded a National Institute of Health grant to study the effects of alcohol on gastrointestinal physiology.

This has been an effective scientific team for the last three years. We are fortunate to have attracted them from the University of Oklahoma and The University of Texas would be well served by insuring the maintenance of their productivity.

Your favorable consideration is recommended.

Sincerely yours,

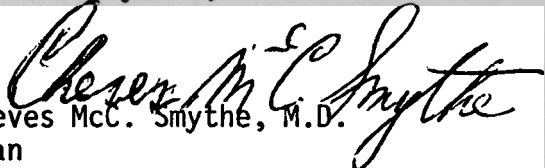
Cheves McC. Smythe, M.D.
Dean

CMS:si
Enclosures

5. System Nursing School: Nomination to Advisory Council of School of Nursing (System-wide) Foundation. --

Chancellor LeMaistre concurs in the request of Dean Marilyn Willman that:

Mr. Arthur I. Ginsburg, Suite 506, Fort Worth Club Building, Fort Worth, Texas 76102

be approved as a member of the Advisory Council of the School of Nursing (System-wide) Foundation.

Following acceptance of Mr. Ginsburg, the entire membership of the Advisory Council will be reported to the Board as an item for the record at a later meeting.

6. Legal Aspects of Future Foundation Grants and Operation (by Chancellor Emeritus Ransom). --

LAW OFFICES OF
COLEMAN GAY

COLEMAN GAY
JOSEPH LATTING

CAPITAL NATIONAL BANK BUILDING
Austin, Texas 78701

September 7, 1971

Mr. Preston Shirley
Attorney at Law
c/o Ms. Betty Ann Thedford, Secretary
The Board of Regents of The University
of Texas System
Austin, Texas 78712

Dear Mr. Shirley:

Texas Student Publications,
Inc./U.T. Regents litigation

On Friday, August 27, 1971, the Board of Directors of Texas Student Publications, Inc., met in executive session and took the action which is reflected by the enclosed minutes.

As you can see, the vote was six in favor of the proposal and one opposed. We had two of our voting members out of state and unable to reach the meeting.

The action of the TSP Board, in essence, calls for both the Regents and the TSP to execute the attached declaration of trust, to make provision so that TSP can pay for its legal expenses, to make provision for the dismissal of the lawsuit with prejudice to both sides, and to make provision for the dissolution of Texas Student Publications, Inc.

In my capacity as attorney for Texas Student Publications, Inc., I hereby formally transmit this offer and proposal, having been officially instructed to do so by my client, Texas Student Publications, Inc. It is my earnest hope and desire that your client, The University of Texas Board of Regents, will see fit to approve and join us in these actions.

Awaiting your reply, I am

Yours very truly,

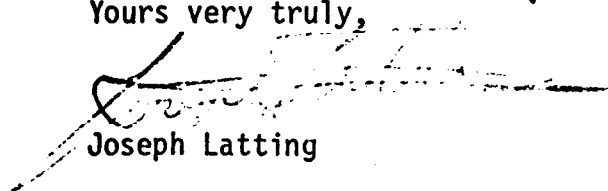
Joseph Latting

JL:md
Encs.

50
Copies
Distributed
at the
meeting
9/8/71
BA2

Minutes
Meeting of the Board of Directors
Texas Student Publications, Inc.
Friday, August 27, 1971

VOTING MEMBERS PRESENT: Bob Binder, Eugene Sauls, David Minberg, Tim Donahue, John Fox, David Stok, Norris Davis.

VOTING MEMBERS ABSENT: Frank Pierce, Charles Bonjean.

NON-VOTING MEMBERS PRESENT: Margaret Berry, Loyd Edmonds, Bob Hilburn, Lori Rodriguez, Jack Stockton, Jan Andrews, Larry Honig, Mack Murrah.

NON-VOTING MEMBERS ABSENT: Stephen Whittaker, John Reetz.

VISITORS PRESENT: Dolores Moore, secretary; Joe Latting and Tom Gee, attorneys.

The meeting was called to order by chairman Binder at 5:50 p.m. in Journalism Building 305.

I. CONSIDERATION OF MOVING INTO EXECUTIVE SESSION: Binder said that because matters of litigation would be discussed, the board should go into executive session.

MOTION NO. 1: Binder moved and it was seconded that the board go into executive session. This motion passed with five voting for and none against.

II. CONSIDERATION OF PROPOSED DECLARATION OF TRUST: Binder requested that all matters discussed in executive session be kept completely confidential. Latting and Gee reviewed what had transpired since the last TSP board meeting concerning the litigation and discussions between the parties. Provisions of the proposed Declaration of Trust were discussed at length. (The complete proposed Declaration of Trust appears as Appendix A in the minutes.)

MOTION NO. 2: Donahue moved, seconded by Minberg that:

1. The 1970-71 TSP Budgets be amended by increasing the allowance for legal expenses from \$4,000 to a total of \$16,000.
2. The proposed Declaration of Trust that appears as Appendix A in these minutes be accepted and offered for execution to the Board of Regents of The University of Texas.
3. The legal action taken by TSP against the Regents be dismissed with prejudice.
4. The corporation known as Texas Student Publications, Inc. be dissolved.

All four provisions are contingent on the Regents approval of the following:

1. The revised budgets providing a total of \$16,000 for legal expenses.
2. Execution of the Declaration of Trust.
3. The TSP Board's proposal to convey its assets to the Regents pursuant to the provisions of the Declaration of Trust.
4. Dismissing the law suit against all defendants with prejudice.

This motion passed with Davis, Binder, Donahue, Sauls, Stok and Minberg voting for; Fox voting against.

Once again the board was reminded by both Latting and Gee that the matter was not settled and there should be no discussion of the matters discussed in executive session.

III. DISCUSSION ON ACTION OF TSP MANAGING EDITOR CONCERNING APPOINTMENTS: The board was told that Reetz, the newly appointed Managing Editor of the Texan, had not followed the board's suggestion in giving Steve Wisch a position on the permanent staff. Members of the board expressed concern that Reetz had not followed the board's suggestion.

The meeting adjourned at 7:50 p.m.

DECLARATION OF TRUST

Texas Student Publications, Inc., acting by and through the undersigned as officers and directors, and the undersigned as officers and directors hereby convey, assign and transfer all assets of Texas Student Publications, Inc., of every kind and character, including, but not limited to, cash, bank accounts, personal property and real property, to the Board of Regents of The University of Texas System (hereinafter referred to as "Trustees") in trust, subject to the terms and conditions of this instrument.

1.

There is hereby created an Operating Board of Trustees, hereinafter called "Operating Trustees", who shall operate as hereinafter provided.

2.

All assets of Texas Student Publications, Inc., are hereby delivered to the Trustees and recorded in the accounting records of The University of Texas at Austin, to be used solely for the maintenance and support of the Texas student publications described in Paragraph 4 below. The recording, budgeting and expenditure of these assets will be in accordance with the Trustees' Rules and Regulations for the management of this type of funds and account.

3.

The operations of student publications on the campus of The University of Texas at Austin are under the control and jurisdiction of the Operating Trustees, constituted as hereinafter set out. All actions of the Operating Trustees and all business connected with student publications on the campus of The University of Texas at Austin conducted by them shall be pursuant to, subject to and in accord with Trustees' Rules and Regulations.

4.

The Operating Trustees are responsible for the issuance, publication and distribution of the student publications on the campus of The University of Texas at Austin. Such publications presently consist of The Daily Texan, The Summer Texan, The Texas Ranger Magazine, Cactus, Peregrinus, Texas Engineering and Science Magazine, and Riata. The Operating Trustees may authorize other publications.

5.

The Board of Operating Trustees is composed of eleven voting members, composed as follows:

- A. Four undergraduate students out of the Journalism Department of The University of Texas at Austin, elected (two to be elected in even-numbered years and two to be elected in odd-numbered years after the initial election; at the initial election under these rules all four shall be elected with provision for staggered terms as hereinafter set out) by those students certified by the chairman of such department as being journalism majors. Said election is to be held at least three weeks before the spring government election each year pursuant to the rules established by the Operating Trustees. No student shall be eligible to be a candidate for a position on the Board of Operating Trustees unless he has completed or will have completed by the end of the spring semester in which the election is held twelve hours of journalism courses, is in good standing (not on scholastic probation), and has completed at least one semester in residence in the long term at The University of Texas at Austin. The eligibility of a candidate must be certified to by the chairman of the Department of Journalism prior to the time of said election.
- B. Two undergraduate students elected at large from the student body of The University of Texas at Austin (one to be elected in even-numbered years and one to be elected in odd-numbered years after the initial election, at the first election under these rules both shall be elected with provision for staggered terms as hereinafter set out) at the same time as

the editor of The Daily Texan, pursuant to Section 11 hereof. If the President of the Students' Association is not one of the students elected at the election, then the President of the Students' Association shall serve as an ex officio member of the Board of Operating Trustees without vote.

- C. Two members of the faculty out of the voting faculty of the Department of Journalism and one member of the faculty out of the voting faculty of the College of Business Administration, all three to be appointed directly by the President of The University of Texas at Austin.
- D. Two professional newspapermen appointed by the President of The University of Texas at Austin.

6.

Voting members of the Board of Operating Trustees shall serve a term of two years beginning June 1 of each calendar year. However, in order to provide staggered terms the following procedure shall be used concerning the first Board of Operating Trustees under this section, to take office on June 1, 1972.

- A. The four journalism students elected from the Department of Journalism shall draw lots in the presence of a quorum of the Board of Operating Trustees to determine which two shall serve initial terms of one year and which two shall serve initial terms of two years.
- B. The two undergraduate students elected at large from the student body of The University of Texas at Austin shall draw lots in the presence of a quorum of the Board of Operating Trustees to determine which one shall serve an initial term of one year and which one shall serve an initial term of two years.
- C. The President of The University of Texas at Austin shall appoint one of the faculty out of the Department of Journalism for an initial term of one year, and he shall appoint the other journalism faculty member for an initial term of two years. The President of The University of Texas at Austin shall appoint the remaining faculty member for an initial term of two years.
- D. The President of The University of Texas at Austin shall appoint one of the professional newspapermen for an initial term of one year, and shall appoint the other professional newspaperman for an initial term of two years.

7.

Should any voting member or members of the Board of Operating Trustees resign, become ineligible or for any other reason fail to serve, if such member be one who was appointed by the President of The University of Texas at Austin, such President, after consultation with the Operating Trustees, shall appoint a successor, and if such member be one who is otherwise selected, then a majority of the Operating Trustees, shall appoint a successor, and if such member be one who is otherwise selected, then a majority of the Operating Trustees, after consultation with the President, shall appoint a successor trustee, and in the event of a tie vote by the Operating Trustees, the President shall make such appointment. Each successor trustee shall possess the qualifications of his predecessor in office.

8.

In addition to the aforementioned voting members of the Board of Operating Trustees, the following persons shall serve as ex officio, non-voting members: The Dean of Students or his representative; the Editorial Manager of The Daily Texan; the General Manager of the publications; the Editor and Managing Editor of The Daily Texan; and the student editors of all other publications published by the Operating Trustees.

9.

Until the selection of the initial eleven-member Board of Operating Trustees as set out under Paragraph 5 hereof, there shall be nine (9) Operating Trustees as follows:

<u>Name</u>	<u>Address</u>
Mr. Bob Binder	Students Association Union Bldg. 323 The University of Texas at Austin Austin, Texas 78712
Dr. Norris Davis	3303 River Road Austin, Texas 78703
Dr. Charles Bonjean	Route 8, Box 428 Austin, Texas 78703
Dr. Eugene Sauls	5801 Westslope Austin, Texas 78731
Dr. Frank Pierce	4202 Venabo Austin, Texas 78731
Mr. David Stok	2208 Nueces Austin, Texas 78705
Mr. David Mincberg	2600 Rio Grande Austin, Texas 78705
Mr. Tim Donahue	3509 Cherry Lane Austin, Texas 78703
Mr. John Fox	401 West 38th Austin, Texas 78705

10.

The officers of the Board of Operating Trustees shall be a President, a Vice-President and a Secretary, and such other officers as the Board of Operating Trustees may from time to time find necessary to carry on the business of the publications. Officers shall be elected from among the voting members of the Board of Operating Trustees at the first meeting after June 1 of each year. Officers' terms shall be for one year, but a person is eligible to serve on additional one-year term.

11.

At least three weeks prior to the spring student government elections, there shall be a student publications election on the campus of The University of Texas at Austin. At such election there shall be elected the Editor of The Daily Texan by the students of The University of Texas at Austin, but voting members of the Board of Operating Trustees shall appoint the Editor of The Daily Texan in the case of a vacancy. The eligibility of a candidate for Editor of The Daily Texan must be certified to by the Operating Trustees on standards set out in their Handbook prior to the time of said election. The Operating Trustees shall set out in its Handbook the conditions under which said elections may be held, including length of the campaign. The Editor of The Daily Texan shall serve for a term of one year beginning on June 1. There shall also be elected at this election the two student members of the Board of Operating Trustees (one student to be elected each year after the first spring election) as provided in Section 5 B.

12.

Subject to the provisions of this instrument, in the performance of all of its duties and in the exercise of all of its powers, the Board of Operating Trustees shall be subject to the direction of the Regents' Rules and Regulations. The Board of Operating Trustees shall conduct its meetings in strict adherence to Roberts' Rules of Order.

13.

There shall be an Executive Committee of the Board of Operating Trustees to be composed of three faculty members and two journalism students to be elected by the Board of Operating Trustees from its membership.

14.

The Executive Committee shall appoint a General Manager who shall be selected annually during the month of May for the fiscal year beginning September 1. The Executive Committee shall determine the compensation of the General Manager. The duties of the General Manager shall be prescribed by the Executive Committee, subject to the basic policies set forth by the Operating Trustees. The Editorial Manager(s) will be appointed by the Executive Committee, subject to basic policies set forth by the Operating Trustees. The Executive Committee shall determine the compensation of the Editorial Manager(s). The Editorial Manager of The Daily Texan shall be authorized to coordinate the activities between The Daily Texan and the Department of Journalism so as to secure the most effective use of the journalism laboratories and classes in the preparation of material for The Daily Texan. The Executive Committee shall fix the compensation of all editorial workers on student publications, subject to the final approval of the Operating Trustees. The Executive Committee shall appoint and fill all vacancies for Editor and Managing Editor of every publication, except The Daily Texan, and shall fix their compensation subject to final approval of the Operating Trustees at their next regular meeting.

15.

The Executive Committee is authorized to implement and is responsible for implementation of the policies of the Operating Trustees between meetings of the Operating Trustees.

16.

A definitive relationship between the Department of Journalism of The University of Texas at Austin and The Daily Texan published by the Operating Trustees must exist. Accordingly, the President of The University of Texas at Austin shall promulgate an operating procedure to establish this relationship. The operating procedure may be amended from time to time by mutual agreement between the Department of Journalism, through its chairman, and the Operating Trustees, with the concurrence of the President of The University of Texas at Austin. In the event the Chairman of the Department and the Board of Operating Trustees are unable to agree on amendments, the President of The University of Texas at Austin shall make the final decision.

17.

There shall be established within the Board of Operating Trustees a Review Committee which shall be composed of one member of the journalism faculty, one journalism student, and one professional newspaperman. Such members are to be elected by the Operating Trustees out of the membership of the Board of Operating Trustees. All appeals on material withheld from publication by the Editorial Manager, or respective publications supervisors, shall be considered by the Review Committee within 24 hours of the action. A decision of the Review Committee may be appealed to the Operating Trustees, but seven affirmative votes of the Operating Trustees are required to overrule said decision of the Review Committee. In all such matters, the actions of the Operating Trustees shall be final and complete without review outside the Operating Trustees.

18.

It shall be the duty of the Board of Operating Trustees to furnish on request to the President of The University of Texas at Austin, the Chancellor of The University of Texas System and the Board of Regents of The University of Texas System, within two weeks of such request, any special reports requested by such officials.

19.

At least eighteen copies of the minutes of all meetings of the Operating Trustees shall be delivered promptly to the President of The University of Texas at Austin for distribution to the Chancellor, the Vice-Chancellor for Academic Affairs, the members of the Board of Regents, the Secretary to the Board of Regents and such members of The University of Texas at Austin administration as the President of The University of Texas at Austin may direct. No action of the Operating Trustees shall have any force or effect unless included in the minutes and until it has been approved by the President of The University of Texas at Austin, except actions of the Operating Trustees pertaining to decisions of the Review Committee,

and except as to actions of the Operating Trustees with respect to the appointment, discipline or removal of editors, which actions need only be reported in the minutes for information, but are not reviewable outside the Board of Operating Trustees.

20.

No budget or budget amendment adopted by the Operating Trustees shall have any force or effect until such budget or budget amendment has been approved by the Board of Regents.

21.

No expenditure shall be made by the Operating Trustees unless it is made in accordance with and pursuant to a budget item that has been previously adopted by the Operating Trustees and approved by the Board of Regents.

22.

Within ninety days following the close of each fiscal year, the President of The University of Texas at Austin shall be furnished for distribution to the Chancellor and to the members of the Board of Regents, the Secretary to the Board of Regents and to such members of The University of Texas at Austin administration as the President of The University of Texas at Austin may direct, at least fifteen copies of a complete audit of the fiscal year.

23.

All employees, editors, editorial workers and staff members employed to work on student publications under the control and jurisdiction of the Operating Trustees including all employees of the corporation known as Texas Student Publications, Inc. holding office or employed as of the effective date of this Declaration of Trust shall continue in office or employment (unless changed by the Operating Trustees in accordance with the Declaration of Trust).

24.

Subject to Section 23 of this Declaration of Trust, the Operating Trustees shall have the authority: (1) to appoint the Managing Editor of The Daily Texan from among qualified students; (2) to take disciplinary action against the employees editors, editorial workers and staff members of student publications, including the removal from office after due notice, for a violation of the policies of the Operating Trustees or for nonperformance of duties; such removal shall require a majority vote (action of the Operating Trustees in the matter of the appointment, discipline and removal of editors shall be final and complete); provided, however, that no action taken by the Operating Trustees with respect to the employment, dismissal, salary or duties and responsibilities of either the General Manager or the Editorial Manager(s) shall have any force or effect until it has been approved by the Board of Regents; and (3) to determine the character and policies of all student publications.

25.

Since all funds utilized in the operations of student publications are under the direct control of an agency of the University, the Operating Trustees, the Vice-President for Business Affairs of The University of Texas at Austin and the Director of The University of Texas at Austin Personnel Office shall immediately make arrangements for assuring that all appropriate personnel are placed under the budgetary and personnel regulations applicable to other University of Texas at Austin employees.

26.

The Operating Trustees shall promulgate and implement a handbook which shall contain the operating policies of the Operating Trustees.

27.

The provisions of this instrument may be amended only with the concurrence of Trustees and a majority of the Operating Trustees.

28.

Trustees, by the execution of this instrument, accept the assets hereby conveyed and delivered, subject to all of the terms and provisions of this instrument.

TEXAS STUDENT PUBLICATIONS, INC.

ATTEST:

By: _____
Bob Binder, Chairman

David Mincberg, Secretary

DIRECTORS

1. _____
2. _____
3. _____
4. _____
5. _____
6. _____

THE BOARD OF REGENTS OF THE UNIVERSITY
OF TEXAS SYSTEM

ATTEST:

By: _____
John Peace, Chairman

Betty Ann Thedford, Secretary

**Meeting of
the Board**

AGENDA
MEETING OF THE BOARD OF REGENTS
OF
THE UNIVERSITY OF TEXAS SYSTEM

Chairman Peace, Presiding

Date: September 8, 1971

Time: Following the meeting of the Committee of the Whole

Place: Main Building, Room 212
The University of Texas at Austin
Austin, Texas

A. CALL TO ORDER

B. CONSIDERATION OF MINUTES OF MEETING HELD ON
JULY 30, 1971.

C. SPECIAL ITEMS

1. Chancellor LeMaistre

2. Chief Administrative Officers of the Component
Institutions

- a. U. T. Austin (President Spurr)
- b. U. T. El Paso (President Smiley)
- c. U. T. Arlington (President Harrison)
- d. U. T. Dallas (President Jordan)
- e. Dallas Medical School (Dean Sprague)
- f. U. T. San Antonio (President Templeton)
- g. San Antonio Medical School (Dean Pannill)
- h. San Antonio Dental School (Dean Olson)
- i. Texan Cultures Institute (Mr. Shuffler)
- j. U. T. Permian Basin (President Amstead)
- k. Galveston Medical Branch (President Blocker)
- l. Houston Medical School (Dean Smythe)
- m. Houston Dental Branch (Dean Olson)
- n. M. D. Anderson (President Clark)

- o. G. S. B. S. (Dean Knudson)
 - p. Public Health School (Dean Stallones)
 - q. System Nursing School (Dean Willman)
3. Members of the Board of Regents
- a. Chairman Peace
 - b. Vice-Chairman Ikard
 - c. Regent Erwin
 - d. Regent Garrett
 - e. Regent (Mrs.) Johnson
 - f. Regent Kilgore
 - g. Regent McNeese
 - h. Regent Nelson
 - i. Regent Williams

D. REPORTS OF STANDING COMMITTEES

- 1. Executive Committee
- 2. Academic and Developmental Affairs Committee
- 3. Buildings and Grounds Committee
- 4. Land and Investment Committee
- 5. Medical Affairs Committee
- 6. Board for Lease of University Lands

E. REPORTS OF SPECIAL COMMITTEES, IF ANY

F. REPORT OF COMMITTEE OF THE WHOLE

G. ADJOURNMENT

**COMMITTEE OF THE WHOLE
EXECUTIVE SESSION**

September 8, 1971

The items listed on the Agenda of the Executive Session of the Committee of the Whole relate either to personnel matters, land acquisition, and security or to items requiring legal consultation.

BOARD OF REGENTS OF THE UNIVERSITY OF TEXAS SYSTEM
September 8, 1971

STRICTLY
EXECUTIVE SESSION

	<u>Page No.</u>
1. U. T. System: Legal Matters Relating to Marine Biomedical Institute	2
2. U. T. Austin: Legal Considerations Concerning Agreement with Travis County Legal Aid and Defender Society	9
2a. U. T. Austin: Legal Aspects Relating to Student Publications	14
3. Dallas Medical School: Waiver of <u>Rules and Regulations</u> Regarding Retirement	14
4. Houston Medical School: Waiver of <u>Rules and Regulations</u> Regarding Nepotism	15
5. System Nursing School: Nomination to Advisory Council of School of Nursing (System-wide) Foundation	16
6. Legal Aspects of Future Foundation Grants and Operation (by Chancellor Emeritus Ransom)	16

REMINDER TO CHAIRMAN PEACE

Similar item for Houston Medical School on Page 62 of Minutes of April 23, 1971, relating to employment of Drs. Emil and Anna Steinberger.